

Modular DIN Rail Products





CHINT

CHINT



CHINA+TOMORROW= CHINT

"CHIN" indicates "CHINA", and "T" represents "TOMORROW",
proclaiming its signification-"Tomorrow of China".



Zhejiang CHINT Electrics Co.,Ltd. (public company, SHA:601877) is the largest-selling low-voltage electrics manufacturers in China. The company mainly engages in the research & development, manufacturing and sales of over 100 series low-voltage products with over 10,000 specification, such as modular Din-rail products, Moulded Case Circuit Breaker, Control products, Relays, Inverters, Soft Starters, Transformers, Automatic Voltage Regulators, Capacitors, Switch Disconnections, etc. and provides integrated electrical system solution for the industries of electric power, machinery, building, communication, HVAC, metallurgy, petrochemical, railway and etc.



With its worldwide presence of distribution network,
CHINT is capable of delivering high quality and professional services
for its customers at home and abroad.



CHINT is consistently committed to developing itself into a world-class electric supplier of integrated system solutions in this era of economic globalization. By adhering to the development strategy of "internationalization, High-Technology and Industrialization", the company has persistently devoted itself to the innovation measures in corporate system, technology, and management with a vision of offering global customers with high-performance, intelligent and energy-saving electric products, technologies and services.



.....



Marketing Network

Chint not only has advanced production equipment, strict quality management and innovative research and development team, but also a worldwide marketing network consisting of 5 international marketing areas, 13 domestic marketing offices, 12 logistics centers, more than 280 specialty stores and more than 1000 sales companies, which are always ready to provide the users with high-quality professional services.





Europe



America



CIS Region



West Asia & Africa



Asia-Pacific



CHINT Electric Systems

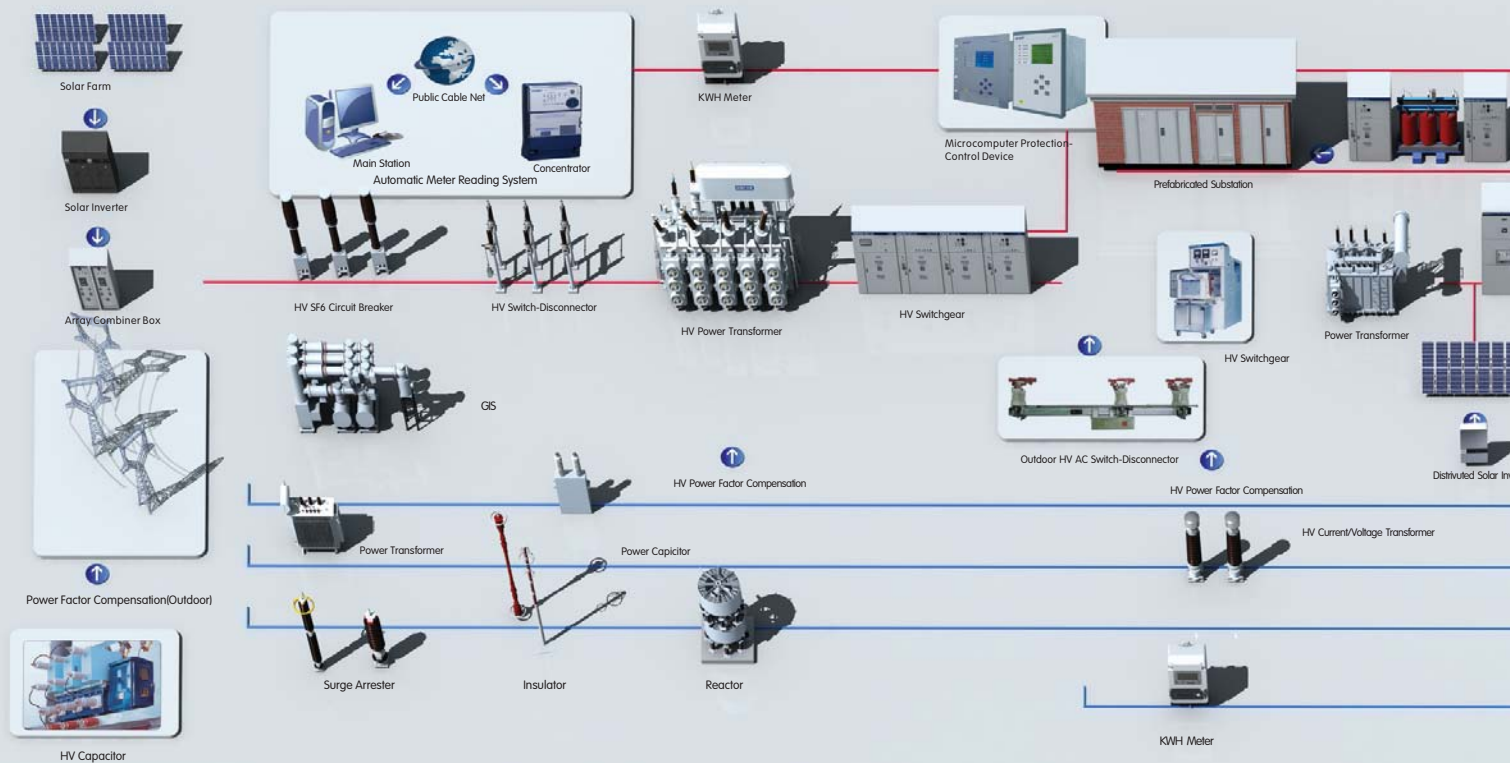

Power of Dedication has transformed CHINT from a simple electric component manufacturer into a leading electric system solution provider, enabling all users from power transmission, distribution and usage sectors to access more reliable, secure, energy-saving, precise, eco-friendly, and intelligent electric products and services. CHINT highly values all personalized demands of electric power, machinery, construction, communications, HVAC, metallurgy, petrochemical, railway, and other industries all the time, and devote itself to facilitating technical innovations and building a green future by providing users with world-class tailor-made electric system solutions.

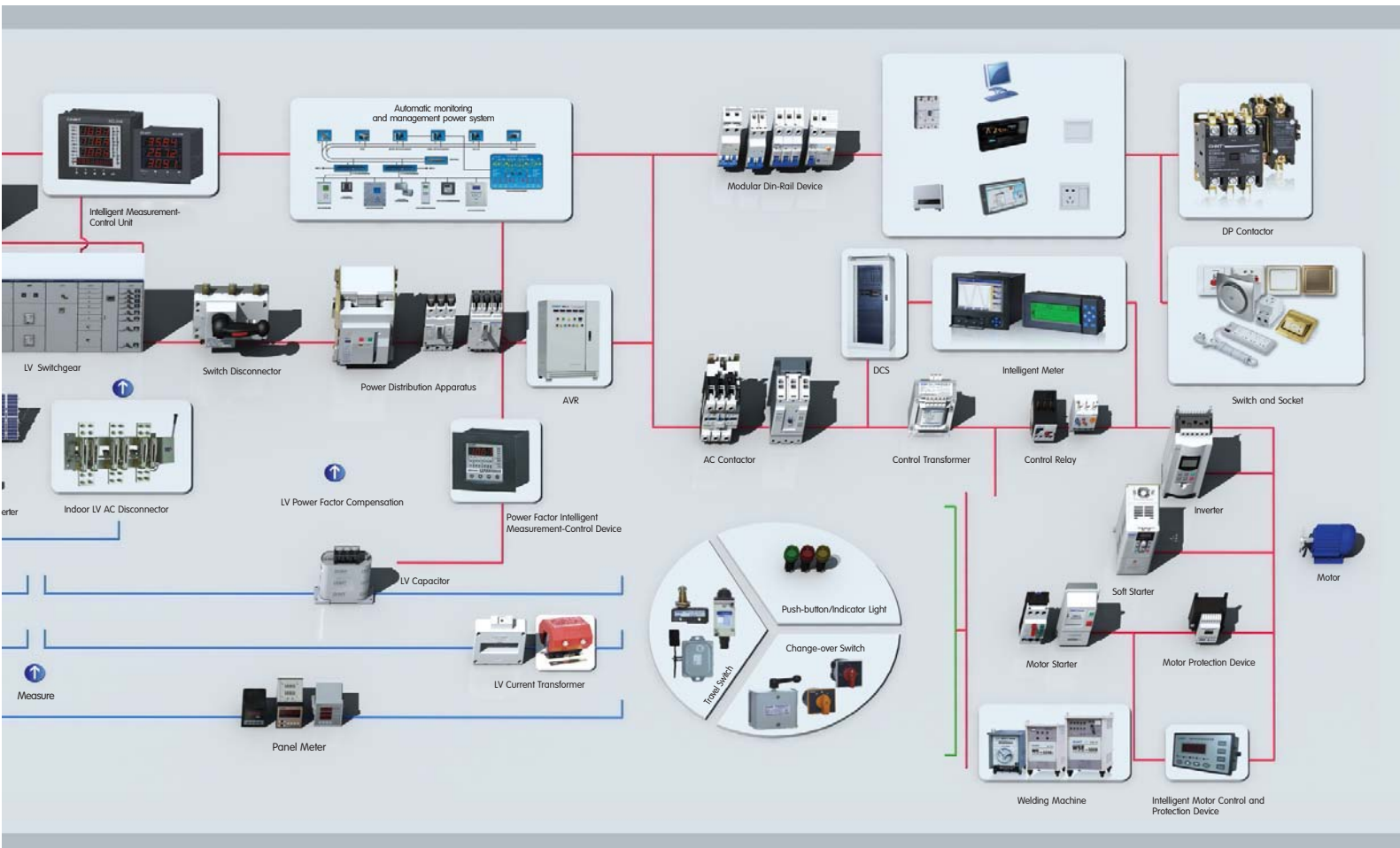

Modular DIN Rail Products

MCB



NB1
In: 1~63A
Icn=6000A,
10000A

Page 01



NB7
In: 63A

Page 13



EB
In: 1~63A
Icn=3000A,
4500A

Page 15



UB
In: 6~40A
Icn=6000A

Page 21



DZ158
In: 63A, 80A,
100A, 125A
Icu=6kA, 10kA

Page 25



NBH8
In: 1~40A
Icn=4500A,
6000A

Page 29

RCCB



NL1
Magnetic
type

Page 32

Modular DIN Rail Products

Accessories for MCB, RCBO



XF9
Auxiliary
contact

Page 69



XF9J
Alarm
auxiliary
contact

Page 71



S9
Shunt
release

Page 73



V9
Under-voltage
release

Page 75



AX-1
Auxiliary
contact

Page 77

Switch Disconnecter



NH2
In=32A,
63A, 100A

Page 79



NH4
In=32A,
63A, 100A,
125A

Page 82

RCBO



NB1L
Magnetic
type

Page 36



NB7LE

Page 52



NB3LE
Electronic
type

Page 56



NB3LEU
Electronic
type

Page 59



NBH8LE
Electronic
type

Page 62



DZ158LE
Electronic
type

Page 65

Surge Arrester



NU6

Page 85

Pushbutton & Indicator



NP9
Pushbutton

Page 101



ND9
Indicator
light

Page 103

Modular DIN Rail Products

Consumer Unit



NX8

Page 106



NX2

Page 108



NXW1

Page 109

Wall Mounting Enclosure



NXW5

Page 110

Bus Bar / Din Rail



MCB shield

Page 114



**Busbar for
MCB & RCCB**

Page 115



**Busbar for
RCBO**

Page 116



DIN rail

Page 116

Change-over Switch



NZK1

Page 117



NZK2

Page 119

NB1 Miniature Circuit Breaker





NB1 Miniature Circuit Breaker

1. General

1.1 Function

protection of circuits against short-circuit currents,
protection of circuits against overload currents,
switch,
isolation,

NB1 circuit-breakers are used in domestic installation,
as well as in commercial and industry electrical
distribution systems.

1.2 Selection

Technical data of the network at the point considered:
the earthing systems (TNS, TNC),
short-circuit current at the circuit-breaker installation point,
which must always be less than the breaking capacity of
this device,

Network normal voltage.

Tripping curves:

B curve (3-5I_n)

protection for people and big length cables in TN and IT
systems.

C curve (5-10I_n)

protection for resistive and inductive loads with low inrush
current.

D curve(10-14I_n)

protection for circuits which supply loads with high inrush
current at the circuit closing

(LV/LV transformers, breakdown lamps).

1.3 Approvals and certificates

Detailed information, please refer to Certificates Table
on the last page.



2. Ordering information

2.1 IEC/EN 60898-1

Icn=6000A, AC type
(Icu=10kA IEC/EN 60947-2)

★ NB1, 1P



In (A)	CTN	Order Code					
		Curve B		Curve C		Curve D	
		Standard	RoHS	Standard	RoHS	Standard	RoHS
1	180	131001	971276	131053	971332	131105	971388
2	180	131002	971277	131054	971333	131106	971389
3	180	131003	971278	131055	971334	131107	971390
4	180	131004	971279	131056	971335	131108	971391
6	180	131005	971280	131057	971336	131109	971392
10	180	131006	971281	131058	971337	131110	971393
16	180	131007	971283	131059	971339	131111	971395
20	180	131008	971284	131060	971340	131112	971396
25	180	131009	971285	131061	971341	131113	971397
32	180	131010	971286	131062	971342	131114	971398
40	180	131011	971287	131063	971343	131115	971399
50	180	131012	971288	131064	971344	131116	971400
63	180	131013	971289	131065	971345	131117	971401

Icn=6000A, AC type

★ NB1, 1P+N



In (A)	CTN	Order Code					
		Curve B		Curve C		Curve D	
		RoHS		RoHS		RoHS	
1	90	984949		984963		984977	
2	90	984950		984964		984978	
3	90	984951		984965		984979	
4	90	984952		984966		984980	
6	90	984953		984967		984981	
10	90	984954		984968		984982	
16	90	984956		984970		984984	
20	90	984957		984971		984985	
25	90	984958		984972		984986	
32	90	984959		984973		984987	
40	90	984960		984974		984988	
50	90	984961		984975		984989	
63	90	984962		984976		984990	

Icn=6000A, AC type
(Icu=10kA IEC/EN 60947-2)

★ NB1, 2P



In (A)	CTN	Order Code					
		Curve B		Curve C		Curve D	
		Standard	RoHS	Standard	RoHS	Standard	RoHS
1	90	131014	971290	131066	971346	131118	971402
2	90	131015	971291	131067	971347	131119	971403
3	90	131016	971292	131068	971348	131120	971404
4	90	131017	971293	131069	971349	131121	971405
6	90	131018	971294	131070	971350	131122	971406
10	90	131019	971295	131071	971351	131123	971407
16	90	131020	971297	131072	971353	131124	971409
20	90	131021	971298	131073	971354	131125	971410
25	90	131022	971299	131074	971355	131126	971411
32	90	131023	971300	131075	971356	131127	971412
40	90	131024	971301	131076	971357	131128	971413
50	90	131025	971302	131077	971358	131129	971414
63	90	131026	971303	131078	971359	131130	971415

Icn=6000A, AC type
(Icu=10kA IEC/EN 60947-2)

★ NB1, 3P



In (A)	CTN	Order Code					
		Curve B		Curve C		Curve D	
		Standard	RoHS	Standard	RoHS	Standard	RoHS
1	60	131027	971304	131079	971360	131131	971416
2	60	131028	971305	131080	971361	131132	971417
3	60	131029	971306	131081	971362	131133	971418
4	60	131030	971307	131082	971363	131134	971419
6	60	131031	971308	131083	971364	131135	971420
10	60	131032	971309	131084	971365	131136	971421
16	60	131033	971311	131085	971367	131137	971423
20	60	131034	971312	131086	971368	131138	971424
25	60	131035	971313	131087	971369	131139	971425
32	60	131036	971314	131088	971370	131140	971426
40	60	131037	971315	131089	971371	131141	971427
50	60	131038	971316	131090	971372	131142	971428
63	60	131039	971317	131091	971373	131143	971429

Icn=6000A, AC type

★ NB1, 3P+N



In (A)	CTN	Order Code					
		Curve B		Curve C		Curve D	
		Standard	RoHS	Standard	RoHS	Standard	RoHS
1	45	984991		985005		985019	
2	45	984992		985006		985020	
3	45	984993		985007		985021	
4	45	984994		985008		985022	
6	45	984995		985009		985023	
10	45	984996		985010		985024	
16	45	984998		985012		985026	
20	45	984999		985013		985027	
25	45	985000		985014		985028	
32	45	985001		985015		985029	
40	45	985002		985016		985030	
50	45	985003		985017		985031	
63	45	985004		985018		985032	

Icn=6000A, AC type
(Icu=10kA IEC/EN 60947-2)

★ NB1, 4P



In (A)	CTN	Order Code					
		Curve B		Curve C		Curve D	
		Standard	RoHS	Standard	RoHS	Standard	RoHS
1	45	131040	971318	131092	971374	131144	971430
2	45	131041	971319	131093	971375	131145	971431
3	45	131042	971320	131094	971376	131146	971432
4	45	131043	971321	131095	971377	131147	971433
6	45	131044	971322	131096	971378	131148	971434
10	45	131045	971323	131097	971379	131149	971435
16	45	131046	971325	131098	971381	131150	971437
20	45	131047	971326	131099	971382	131151	971438
25	45	131048	971327	131100	971383	131152	971439
32	45	131049	971328	131101	971384	131153	971440
40	45	131050	971329	131102	971385	131154	971441
50	45	131051	971330	131103	971386	131155	971442
63	45	131052	971331	131104	971387	131156	971443

2.2 IEC/EN 60898-1

Icn=10000A, AC type

1~32A, Icu=15kA, IEC/EN 60947-2

40~63A, Icu=10kA, IEC/EN 60947-2

★ NB1, 1P



In (A)	CTN	Order Code					
		Curve B		Curve C		Curve D	
		Standard	RoHS	Standard	RoHS	Standard	RoHS
1	180	131761	971780	131817	971836	131873	971892
2	180	131762	971781	131818	971837	131874	971893
3	180	131763	971782	131819	971838	131875	971894
4	180	131764	971783	131820	971839	131876	971895
6	180	131765	971784	131821	971840	131877	971896
10	180	131766	971785	131822	971841	131878	971897
16	180	131768	971787	131824	971843	131880	971899
20	180	131769	971788	131825	971844	131881	971900
25	180	131770	971789	131826	971845	131882	971901
32	180	131771	971790	131827	971846	131883	971902
40	180	131772	971791	131828	971847	131884	971903
50	180	131773	971792	131829	971848	131885	971904
63	180	131774	971793	131830	971849	131886	971905

Icn=10000A, AC type

★ NB1, 1P+N



In (A)	CTN	Order Code		
		Curve D		
		Standard	RoHS	RoHS
1	90	985033	985047	985061
2	90	985034	985048	985062
3	90	985035	985049	985063
4	90	985036	985050	985064
6	90	985037	985051	985065
10	90	985038	985052	985066
16	90	985040	985054	985068
20	90	985041	985055	985069
25	90	985042	985056	985070
32	90	985043	985057	985071
40	90	985044	985058	985072
50	90	985045	985059	985073
63	90	985046	985060	985074

Icn=10000A, AC type
1~32A, Icu=15kA, IEC/EN 60947-2
40~63A, Icu=10kA, IEC/EN 60947-2

★ NB1, 2P



Icn=10000A, AC type
1~32A, Icu=15kA, IEC/EN 60947-2
40~63A, Icu=10kA, IEC/EN 60947-2

★ NB1, 3P



In (A)	CTN	Order Code					
		Curve B		Curve C		Curve D	
		Standard	RoHS	Standard	RoHS	Standard	RoHS
1	90	131775	971794	131831	971850	131887	971906
2	90	131776	971795	131832	971851	131888	971907
3	90	131777	971796	131833	971852	131889	971908
4	90	131778	971797	131834	971853	131890	971909
6	90	131779	971798	131835	971854	131891	971910
10	90	131780	971799	131836	971855	131892	971911
16	90	131782	971801	131838	971857	131894	971913
20	90	131783	971802	131839	971858	131895	971914
25	90	131784	971803	131840	971859	131896	971915
32	90	131785	971804	131841	971860	131897	971916
40	90	131786	971805	131842	971861	131898	971917
50	90	131787	971806	131843	971862	131899	971918
63	90	131788	971807	131844	971863	131900	971919

In (A)	CTN	Order Code					
		Curve B		Curve C		Curve D	
		Standard	RoHS	Standard	RoHS	Standard	RoHS
1	60	131789	971808	131845	971864	131901	971920
2	60	131790	971809	131846	971865	131902	971921
3	60	131791	971810	131847	971866	131903	971922
4	60	131792	971811	131848	971867	131904	971923
6	60	131793	971812	131849	971868	131905	971924
10	60	131794	971813	131850	971869	131906	971925
16	60	131796	971815	131852	971871	131908	971927
20	60	131797	971816	131853	971872	131909	971928
25	60	131798	971817	131854	971873	131910	971929
32	60	131799	971818	131855	971874	131911	971930
40	60	131800	971819	131856	971875	131912	971931
50	60	131801	971820	131857	971876	131913	971932
63	60	131802	971821	131858	971877	131914	971933

Icn=10000A, AC type

★ NB1, 3P+N



Icn=10000A, AC type
1~32A, Icu=15kA, IEC/EN 60947-2
40~63A, Icu=10kA, IEC/EN 60947-2

★ NB1, 4P



In (A)	CTN	Order Code		
		Curve B	Curve C	Curve D
		RoHS	RoHS	RoHS
1	45	985075	985089	985103
2	45	985076	985090	985104
3	45	985077	985091	985105
4	45	985078	985092	985106
6	45	985079	985093	985107
10	45	985080	985094	985108
16	45	985082	985096	985110
20	45	985083	985097	985111
25	45	985084	985098	985112
32	45	985085	985099	985113
40	45	985086	985100	985114
50	45	985087	985101	985115
63	45	985088	985102	985116

In (A)	CTN	Order Code					
		Curve B		Curve C		Curve D	
		Standard	RoHS	Standard	RoHS	Standard	RoHS
1	45	131803	971822	131859	971878	131915	971934
2	45	131804	971823	131860	971879	131916	971935
3	45	131805	971824	131861	971880	131917	971936
4	45	131806	971825	131862	971881	131918	971937
6	45	131807	971826	131863	971882	131919	971938
10	45	131808	971827	131864	971883	131920	971939
16	45	131810	971829	131866	971885	131922	971941
20	45	131811	971830	131867	971886	131923	971942
25	45	131812	971831	131868	971887	131924	971943
32	45	131813	971832	131869	971888	131925	971944
40	45	131814	971833	131870	971889	131926	971945
50	45	131815	971834	131871	971890	131927	971946
63	45	131816	971835	131872	971891	131928	971947

2.3 IEC/EN 60947-2/ VC8036

Icu=6kA, AC type

★ NB1, 1P



In (A)	CTN	Order Code			
		10 In		12 In	
		Standard	RoHS	Standard	RoHS
1	180	139320	985379	190192	986592
2	180	139321	985380	190193	986593
3	180	139322	985381	190194	986594
4	180	139323	985382	190195	986595
6	180	139324	985383	190196	986596
10	180	139325	985384	190197	986597
16	180	139326	985385	190198	986598
20	180	139327	985386	190199	986599
25	180	139328	985387	190200	986600
32	180	139329	985388	190201	986601
40	180	139330	985389	190202	986602
50	180	139331	985390	190203	986603
63	180	139332	985391	190204	986604

Icu=6kA, AC type

★ NB1, 2P



In (A)	CTN	Order Code			
		10 In		12 In	
		Standard	RoHS	Standard	RoHS
1	90	139333	985392	986605	190205
2	90	139334	985393	986606	190206
3	90	139335	985394	986607	190207
4	90	139336	985395	986608	190208
6	90	139337	985396	986609	190209
10	90	139338	985397	986610	190210
16	90	139339	985398	986611	190211
20	90	139340	985399	986612	190212
25	90	139341	985400	986613	190213
32	90	139342	985401	986614	190214
40	90	139343	985402	986615	190215
50	90	139344	985403	986616	190216
63	90	139345	985404	986617	190217

Icu=6kA, AC type

★ NB1, 3P



In (A)	CTN	Order Code			
		10 In		12 In	
		Standard	RoHS	Standard	RoHS
1	60	139346	985405	190218	986618
2	60	139347	985406	190219	986619
3	60	139348	985407	190220	986620
4	60	139349	985408	190221	986621
6	60	139350	985409	190222	986622
10	60	139351	985410	190223	986623
16	60	139352	985411	190224	986624
20	60	139353	985412	190225	986625
25	60	139354	985413	190226	986626
32	60	139355	985414	190227	986627
40	60	139356	985415	190228	986628
50	60	139357	985416	190229	986629
63	60	139358	985417	190230	986630

Icu=6kA, AC type

★ NB1, 4P



In (A)	CTN	Order Code			
		10 In		12 In	
		Standard	RoHS	Standard	RoHS
1	45	139359	985418	190231	986631
2	45	139360	985419	190232	986632
3	45	139361	985420	190233	986633
4	45	139362	985421	190234	986634
6	45	139363	985422	190235	986635
10	45	139364	985423	190236	986636
16	45	139365	985424	190237	986637
20	45	139366	985425	190238	986638
25	45	139367	985426	190239	986639
32	45	139368	985427	190240	986640
40	45	139369	985428	190241	986641
50	45	139370	985429	190242	986642
63	45	139371	985430	190243	986643

2.4 UL1077

I_{cn}=5kA, AC type

★ NB1, 1P



In (A)	CTN	Order Code		
		Curve B	Curve C	Curve D
		RoHS	RoHS	RoHS
1	180	985223	985275	985327
2	180	985224	985276	985328
3	180	985225	985277	985329
4	180	985226	985278	985330
6	180	985227	985279	985331
10	180	985228	985280	985332
16	180	985229	985281	985333
20	180	985230	985282	985334
25	180	985231	985283	985335
32	180	985232	985284	985336
40	180	985233	985285	985337
50	180	985234	985286	985338
63	180	985235	985287	985339

I_{cn}=5kA, AC type

★ NB1, 2P



In (A)	CTN	Order Code		
		Curve B	Curve C	Curve D
		RoHS	RoHS	RoHS
1	90	985236	985288	985340
2	90	985237	985289	985341
3	90	985238	985290	985342
4	90	985239	985291	985343
6	90	985240	985292	985344
10	90	985241	985293	985345
16	90	985242	985294	985346
20	90	985243	985295	985347
25	90	985244	985296	985348
32	90	985245	985297	985349
40	90	985246	985298	985350
50	90	985247	985299	985351
63	90	985248	985300	985352

I_{cn}=5kA, AC type

★ NB1, 3P



In (A)	CTN	Order Code		
		Curve B	Curve C	Curve D
		RoHS	RoHS	RoHS
1	60	985249	985301	985353
2	60	985250	985302	985354
3	60	985251	985303	985355
4	60	985252	985304	985356
6	60	985253	985305	985357
10	60	985254	985306	985358
16	60	985255	985307	985359
20	60	985256	985308	985360
25	60	985257	985309	985361
32	60	985258	985310	985362
40	60	985259	985311	985363
50	60	985260	985312	985364
63	60	985261	985313	985365

I_{cn}=5kA, AC type

★ NB1, 4P



In (A)	CTN	Order Code		
		Curve B	Curve C	Curve D
		RoHS	RoHS	RoHS
1	45	985262	985314	985366
2	45	985263	985315	985367
3	45	985264	985316	985368
4	45	985265	985317	985369
6	45	985266	985318	985370
10	45	985267	985319	985371
16	45	985268	985320	985372
20	45	985269	985321	985373
25	45	985270	985322	985374
32	45	985271	985323	985375
40	45	985272	985324	985376
50	45	985273	985325	985377
63	45	985274	985326	985378

2.5 UL1077

Icn=10kA, DC type

★ NB1, 1P



Icn=10kA, DC type

★ NB1, 2P



In (A)	CTN	Order Code	
		Curve B	Curve C
		RoHS	RoHS
1	180	985431	985457
2	180	985432	985458
3	180	985433	985459
4	180	985434	985460
6	180	985435	985461
10	180	985436	985462
16	180	985437	985463
20	180	985438	985464
25	180	985439	985465
32	180	985440	985466
40	180	985441	985467
50	180	985442	985468
63	180	985443	985469

In (A)	CTN	Order Code	
		Curve B	Curve C
		RoHS	RoHS
1	90	985444	985470
2	90	985445	985471
3	90	985446	985472
4	90	985447	985473
6	90	985448	985474
10	90	985449	985475
16	90	985450	985476
20	90	985451	985477
25	90	985452	985478
32	90	985453	985479
40	90	985454	985480
50	90	985455	985481
63	90	985456	985482

3. Technical data

3.1 curves

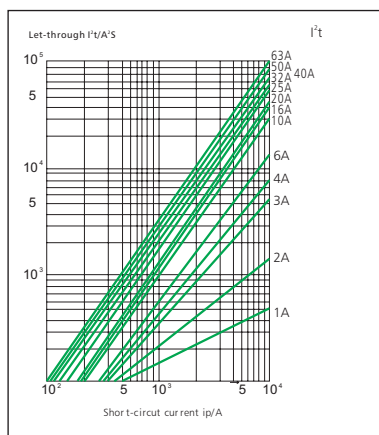
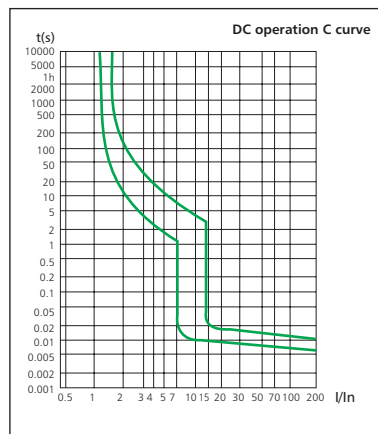
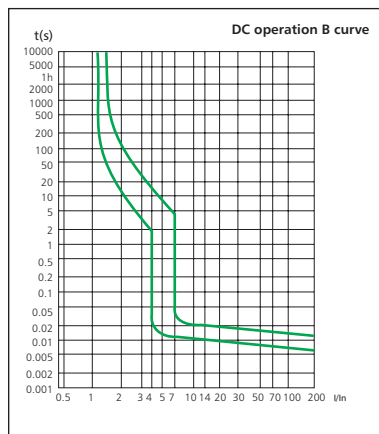
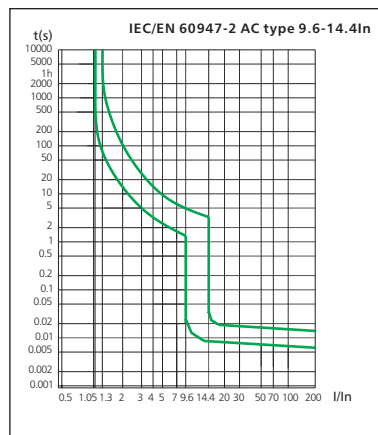
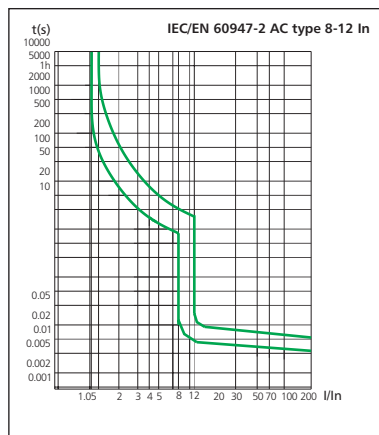
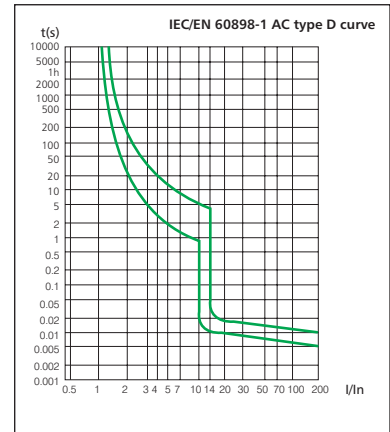
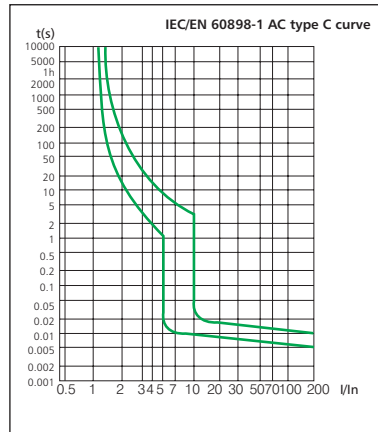
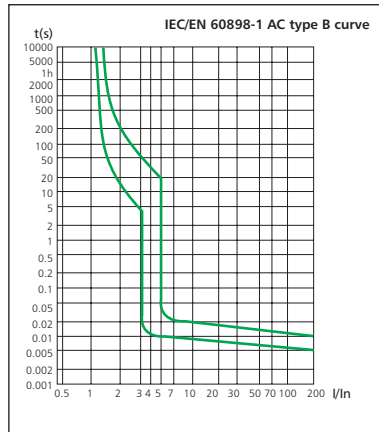

3.2

	Standard		IEC/EN 60898-1	IEC/EN 60947-2	UL1077	UL1077	
Electrical features	Rated current In	A	1, 2, 3, 4, 6, 10, 16, 20, 25, 32, 40, 50, 63		1, 2, 3, 4, 6, 10, 16, 20, 25, 32, 40, 50, 63		
	Poles		1P, 1P+N, 2P, 3P, 3P+N, 4P	1P, 2P, 3P, 4P	1P, 2P, 3P, 4P	1P, 2P	
	Rated voltage Ue	V	230/400~240/415		277/480	110/125	
	Insulation voltage Ui	V	500				
	Rated frequency		50/60Hz			DC	
	Rated breaking capacity	A	6000/10000	6k	5k	10k	
	Energy limiting class		3				
	Rated impulse withstand voltage(1.2/50) Uimp	V	4000				
	Dielectric test voltage at ind. Freq. for 1 min	kV	2				
	Pollution degree		2				
	Power loss per pole			Rated current (A)		Max power loss per pole (W)	
				1, 2, 3, 4, 5, 6, 10		2	
				13, 16, 20, 25, 32		3.5	
			40, 50, 63		5		
Thermo-magnetic release characteristic		B, C, D	8-12In, 9.6-14.4In	B, C, D	4-7In, 7-14In		
Mechanical features	Electrical life		4, 000				
	Mechanical life		20, 000				
	Contact position indicator		Yes				
	Protection degree		IP20				
	Reference temperature for setting of thermal element	°C	30				
	Ambient temperature (with daily average ≤35°C)	°C	-5...+40(Special application please refer to P14 for temperature compensation correction)				
	Storage temperature	°C	-25...+70				
Installation	Terminal connection type		Cable/U-type busbar/Pin-type busbar				
	Terminal size top/bottom for cable	mm ²	25				
		AWG	18-4				
	Terminal size top/bottom for busbar	mm ²	10				
		AWG	18-8				
	Tightening torque	N*m	2.5				
		In-lbs.	22				
Mounting		On DIN rail EN 60715 (35mm) by means of fast clip device					
Connection		From top and bottom					
Combination with accessories	Auxiliary contact		Yes				
	Shunt release		Yes				
	Under voltage release		Yes				
	Alarm contact		Yes				

3.3 Selectivity

In (A)	Power supply side: RT36-00 (fuse)								
	20	25	36	50	63	80	100	125	160
	Is (kA)								
≤2	1.2	4	>12	>12	>12	>12	>12	>12	>12
3	0.7	1.2	3.8	5.3	6	6	6	6	6
4	0.6	0.9	2.5	3.8	6	6	6	6	6
6	0.5	0.8	1.9	2.5	4.5	5	6	6	6
10		0.7	1.4	2.2	3.2	3.6	6	6	6
16			1.2	1.8	2.6	3	5.6	6	6
20				1.5	2.2	2.5	4.6	6	6
25				1.3	2	2.2	4.1	5.5	6
32					1.7	1.9	3.8	4.5	6
40						1.7	3	4	5
50						1.5	2.6	3.5	4.5
63							2.4	3.3	4.5

In (A)	Power supply side: NM8-100S/H/R								
	16	20	25	32	40	50	63	80	100
	Is (kA)								
≤10	0.19	0.19	0.3	0.4	0.5	0.5	0.5	0.63	0.8
16			0.3	0.4	0.5	0.5	0.5	0.63	0.8
20					0.5	0.5	0.5	0.63	0.8
25						0.5	0.5	0.63	0.8
32							0.5	0.63	0.8
40								0.63	0.8
50									0.8
63									

3.4 Backup protection

In (A)	Power supply side: RT16 series						
	40	50	63	80	100	125	160
	Is (kA)						
1~6	40	40	40	40	40	40	40
8~10	40	40	40	40	40	40	40
13	40	40	40	40	35	35	35
16	40	40	40	40	30	30	30
20	40	40	40	40	30	30	30
25	40	40	40	40	30	30	30
32	40	40	40	40	30	30	30
40	40	40	40	40	30	30	30
50	30	30	30	30	30	30	30
63	20	20	20	20	15	15	15

In (A)	Power supply side: NM8					
	NM8-125S	NM8-125H	NM8-125R	NM8-250S	NM8-250H	NM8-250R
	Is (kA)					
1~6	15	18	18	15	15	15
10~20	12	15	15	12	12	12
32~40	12	15	15	12	12	12
50~60	12	15	15	12	12	12

3.5 Temperature derating

The maximum permissible current in a circuit breaker depends on the ambient temperature where the circuit breaker is placed. Ambient temperature is the temperature inside the enclosure or switchboard in which the circuit breakers are installed.
The reference temperature is 30°C

Ambient temperature	-35°C	-30°C	-20°C	-10°C	0°C	10°C	20°C	30°C	40°C	50°C	60°C	70°C
Rated current(A)												
1	1.30	1.26	1.23	1.19	1.15	1.11	1.05	1.00	0.96	0.93	0.88	0.83
2	2.60	2.52	2.46	2.38	2.28	2.20	2.08	2.00	1.92	1.86	1.76	1.66
3	3.90	3.78	3.69	3.57	3.42	3.30	3.12	3.00	2.88	2.79	2.64	2.49
4	5.20	5.04	4.92	4.76	4.56	4.40	4.16	4.00	3.84	3.76	3.52	3.32
6	7.80	7.56	7.38	7.14	6.84	6.60	6.24	6.00	5.76	5.64	5.28	4.98
10	13.20	12.70	12.50	12.00	11.50	11.10	10.60	10.00	9.60	9.30	8.90	8.40
16	21.12	20.48	20.00	19.20	18.40	17.76	16.96	16.00	15.36	14.88	14.24	13.44
20	26.40	25.60	25.00	24.00	23.00	22.20	21.20	20.00	19.20	18.60	17.80	16.8
25	33.00	32.00	31.25	30.00	28.75	27.75	26.50	25.00	24.00	23.25	22.25	21.00
32	42.56	41.28	40.00	38.72	37.12	35.52	33.92	32.00	30.72	29.76	28.16	26.88
40	53.20	51.20	50.00	48.00	46.40	44.80	42.40	40.00	38.40	37.20	35.60	33.6
50	67.00	65.50	63.00	60.50	58.00	56.00	53.00	50.00	48.00	46.50	44.00	41.50
63	83.79	81.90	80.01	76.86	73.71	70.56	66.78	63.00	60.48	58.90	55.44	52.29

When several simultaneously operating circuit breakers are mounted side by side in a small enclosure, the temperature rise inside the enclosure causes a reduction in current rating. You must then assign the rating (already derated if necessary according to ambient temperature) a downrating factor of 0.8.

4. Overall and mounting dimensions (mm)

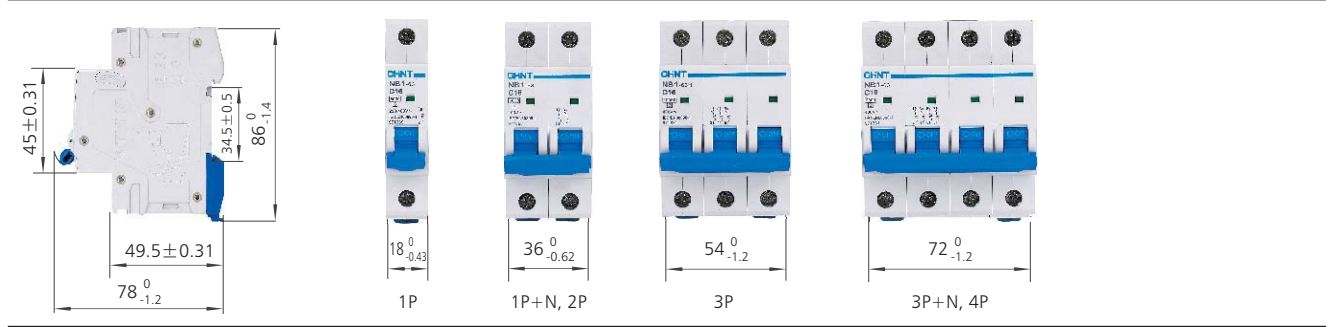



NB7 Miniature Circuit Breaker

1. General

The NB7 series miniature circuit breaker is applicable to the circuit with an alternating current of 50Hz, rated voltage of 230/400V, and rated current up to 63A for overload protection and short circuit protection, and also for not-frequent operational transformation in the circuit under normal condition.

This product can be applied to various places such as industrial, commercial, and tall buildings, and residential houses.

The product meets the standards of IEC60898-1.

2. Type designation

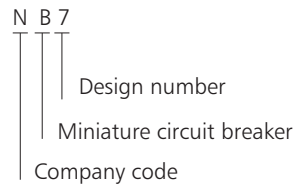

3. Technical data

3.1 Main specifications

- 3.1.1 Graded according to the rated current I_n : 1A, 2A, 3A, 4A, 6A, 10A, 16A, 20A, 25A, 32A, 40A, 50A, 63A;
- 3.1.2 Classified as follows according to the type of instantaneous release: type B (3-5) I_n , type C (5-10) I_n , type D ((10-16) I_n);
- 3.1.3 Categorized as follows according to the number of poles:

- a. Single pole
- b. Two poles
- c. Three poles
- d. Four poles

3.2 Technical parameters

- 3.2.1 For the rated short circuit breaking capacity, see Table 1

Table 1

Rated current I_n (A)	Number of poles	Rated voltage U_e (V)	Rated short circuit capacity I_{cn} (A)
B, C type: 1~40	1	230/400	6000
	2, 3, 4	400	
B, C type: 50 60	1	230/400	4500
	2, 3, 4	400	
D type: 1~63	1	230/400	4500
	2, 3, 4	400	

3.2.2 Mechanical/electrical Life

- a. Electrical life: not less than 4,000 times
- b. Mechanical life: not less than 10,000 times

- 3.2.3 For the over current protection characteristics, see Table 2

Table 2

Test	Type	Test current	Initial state	Time limit for tripping or not tripping	Expected result	Test environment temperature	Remarks
a	B, C, D		Cold state	$t \leq 1h$	Not tripping		
b	B, C, D		Right after test number 1	$t < 1h$	Tripping		The current is rising within 5s
c	B, C, D		Cold state	$1s < t < 60s$ ($I_n \leq 32A$) $1s < t < 120s$ ($I_n > 32A$)	Tripping		
d	B	3 I_n	Cold state	$t \leq 0.1s$	Not tripping	30°C ~35°C	The power supply is turned on by closing the auxiliary switch
	C	5 I_n					
	D	10 I_n					
e	B	5 I_n	Cold state	$t < 0.1s$	Tripping	30°C ~35°C	The power supply is turned on by closing the auxiliary switch
	C	10 I_n					
	D	16 I_n					

Note: The terminology "Cold state" means that the test is performed at the base calibration temperature with no load prior to the test.

3.2.4 For the tripping performance diagram, see Fig 1

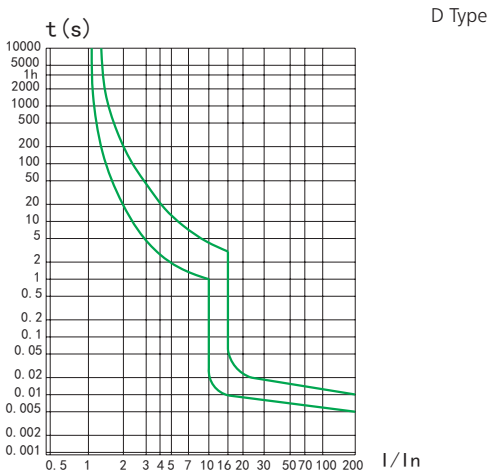
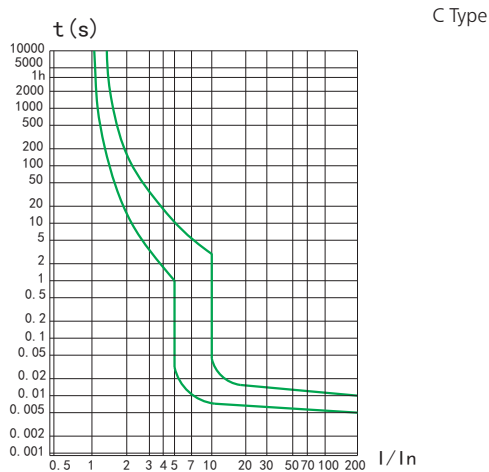
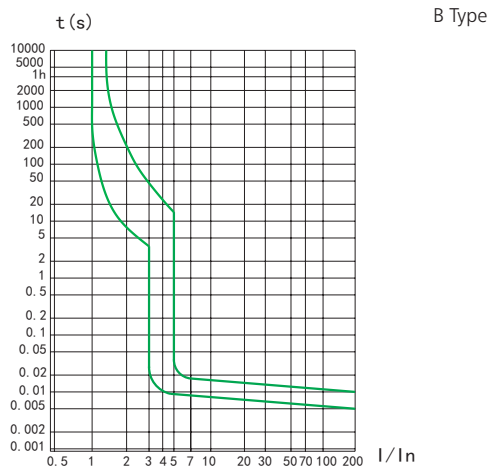

3.2.5 Wiring: good for connection of leads of less than 25mm² (see Table 3); wiring method: screw hold-down with a torque of 2N•m

Rated current In (A)	Nominal cross-sectional area of the copper conductor (mm ²)
1~6	1
10	1.5
16, 20	2.5
25	4
32	6
40, 50	10
63	16

4. Overall and mounting dimensions (mm)

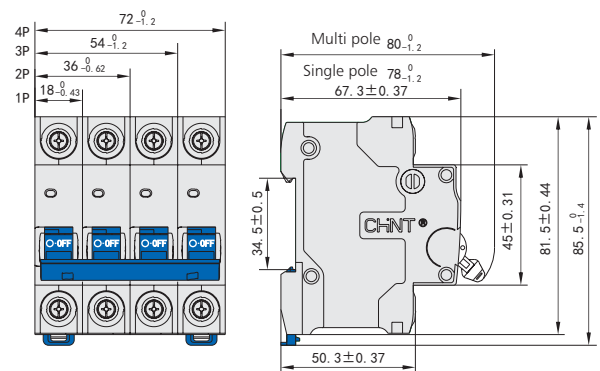

5. Ordering information

- 5.1 When ordering the goods, the user shall indicate the following items:
 - 5.1.1 Types and names of products, for example, NB7 miniature circuit breaker;
 - 5.1.2 Instantaneous tripping type and rated current, for example, C25;
 - 5.1.3 Number of poles: for example, 2P;
 - 5.1.4 Amount on order, for example, 50 units;
- 5.2 Example for ordering: 50 units of the NB7 series miniature circuit breakers, 2P, C25.



eBC eB eBG **Miniature Circuit Breaker**

1. General

1.1 Function

protection of circuits against short-circuit currents,
 protection of circuits against overload currents,
 switch,
 isolation.

1.2 Selection

Technical data of the network at the point considered:
 the earthing systems (TNS, TNC),
 short-circuit current at the circuit-breaker installation point,
 which must always be less than the breaking capacity of
 this device,

Network normal voltage.

Tripping curves:

B curve (3-5I_n)

protection for people and big length cables in TN and IT
 systems.

C curve (5-10I_n)

protection for resistive and inductive loads with low inrush
 current.

D curve(10-14I_n)

protection for circuits which supply loads with high inrush
 current at the circuit closing
 (LV/LV transformers, breakdown lamps).

1.3 Approvals and certificates

Detailed information, please refer to Certificates Table
 on the last page.

- CE
- N
- S
- PC
- RCC
- SAA

2. Ordering information

2.1 IEC/EN 60898-1

Icn=3000A

★ eBC, 1P



In (A)	CTN	Order Code					
		Curve B		Curve C		Curve D	
		Standard	RoHS	Standard	RoHS	Standard	RoHS
1	144	135001	981895	135181	982075	135361	982255
2	144	135002	981896	135182	982076	135362	982256
3	144	135003	981897	135183	982077	135363	982257
4	144	135004	981898	135184	982078	135364	982258
5	144	135005	981899	135185	982079	135365	982259
6	144	135006	981900	135186	982080	135366	982260
10	144	135007	981901	135187	982081	135367	982261
15	144	135008	981902	135188	982082	135368	982262
16	144	135009	981903	135189	982083	135369	982263
20	144	135010	981904	135190	982084	135370	982264
25	144	135011	981905	135191	982085	135371	982265
32	144	135012	981906	135192	982086	135372	982266
40	144	135013	981907	135193	982087	135373	982267
50	144	135014	981908	135194	982088	135374	982268
60	144	135015	981909	135195	982089	135375	982269
63	144	135016	981910	135196	982090	135376	982270

Icn=3000A

★ eBC, 2P



In (A)	CTN	Order Code					
		Curve B		Curve C		Curve D	
		Standard	RoHS	Standard	RoHS	Standard	RoHS
1	72	135046	981940	135226	982120	135393	982287
2	72	135047	981941	135227	982121	135394	982288
3	72	135048	981942	135228	982122	135395	982289
4	72	135049	981943	135229	982123	135396	982290
5	72	135050	981944	135230	982124	135397	982291
6	72	135051	981945	135231	982125	135398	982292
10	72	135052	981946	135232	982126	135399	982293
15	72	135053	981947	135233	982127	135400	982294
16	72	135054	981948	135234	982128	135401	982295
20	72	135055	981949	135235	982129	135402	982296
25	72	135056	981950	135236	982130	135403	982297
32	72	135057	981951	135237	982131	135404	982298
40	72	135058	981952	135238	982132	135405	982299
50	72	135059	981953	135239	982133	135406	982300
60	72	135060	981954	135240	982134	135407	982301
63	72	135061	981955	135241	982135	135408	982302

Icn=3000A

★ eBC, 3P



In (A)	CTN	Order Code					
		Curve B		Curve C		Curve D	
		Standard	RoHS	Standard	RoHS	Standard	RoHS
1	48	135091	981985	135271	982165	135425	982319
2	48	135092	981986	135272	982166	135426	982320
3	48	135093	981987	135273	982167	135427	982321
4	48	135094	981988	135274	982168	135428	982322
5	48	135095	981989	135275	982169	135429	982323
6	48	135096	981990	135276	982170	135430	982324
10	48	135097	981991	135277	982171	135431	982325
15	48	135098	981992	135278	982172	135432	982326
16	48	135099	981993	135279	982173	135433	982327
20	48	135100	981994	135280	982174	135434	982328
25	48	135101	981995	135281	982175	135435	982329
32	48	135102	981996	135282	982176	135436	982330
40	48	135103	981997	135283	982177	135437	982331
50	48	135104	981998	135284	982178	135438	982332
60	48	135105	981999	135285	982179	135439	982333
63	48	135106	982000	135286	982180	135440	982334

Icn=3000A

★ eBC, 4P



In (A)	CTN	Order Code					
		Curve B		Curve C		Curve D	
		Standard	RoHS	Standard	RoHS	Standard	RoHS
1	36	135136	982030	135316	982210	135457	982351
2	36	135137	982031	135317	982211	135458	982352
3	36	135138	982032	135318	982212	135459	982353
4	36	135139	982033	135319	982213	135460	982354
5	36	135140	982034	135320	982214	135461	982355
6	36	135141	982035	135321	982215	135462	982356
10	36	135142	982036	135322	982216	135463	982357
15	36	135143	982037	135323	982217	135464	982358
16	36	135144	982038	135324	982218	135465	982359
20	36	135145	982039	135325	982219	135466	982360
25	36	135146	982040	135326	982220	135467	982361
32	36	135147	982041	135327	982221	135468	982362
40	36	135148	982042	135328	982222	135469	982363
50	36	135149	982043	135329	982223	135470	982364
60	36	135150	982044	135330	982224	135471	982365
63	36	135151	982045	135331	982225	135472	982366

Icn=4500A

★ eB, 1P



In (A)	CTN	Order Code					
		Curve B		Curve C		Curve D	
		Standard	RoHS	Standard	RoHS	Standard	RoHS
1	144	135017	981911	135197	982091	135377	982271
2	144	135018	981912	135198	982092	135378	982272
3	144	135019	981913	135199	982093	135379	982273
4	144	135020	981914	135200	982094	135380	982274
5	144	135021	981915	135201	982095	135381	982275
6	144	135022	981916	135202	982096	135382	982276
10	144	135023	981917	135203	982097	135383	982277
15	144	135024	981918	135204	982098	135384	982278
16	144	135025	981919	135205	982099	135385	982279
20	144	135026	981920	135206	982100	135386	982280
25	144	135027	981921	135207	982101	135387	982281
32	144	135028	981922	135208	982102	135388	982282
40	144	135029	981923	135209	982103	135389	982283
50	144	135030	981924	135210	982104	135390	982284
60	144	135031	981925	135211	982105	135391	982285
63	144	135032	981926	135212	982106	135392	982286

Icn=4500A

★ eB, 2P



In (A)	CTN	Order Code					
		Curve B		Curve C		Curve D	
		Standard	RoHS	Standard	RoHS	Standard	RoHS
1	72	135062	981956	135242	982136	135409	982303
2	72	135063	981957	135243	982137	135410	982304
3	72	135064	981958	135244	982138	135411	982305
4	72	135065	981959	135245	982139	135412	982306
5	72	135066	981960	135246	982140	135413	982307
6	72	135067	981961	135247	982141	135414	982308
10	72	135068	981962	135248	982142	135415	982309
15	72	135069	981963	135249	982143	135416	982310
16	72	135070	981964	135250	982144	135417	982311
20	72	135071	981965	135251	982145	135418	982312
25	72	135072	981966	135252	982146	135419	982313
32	72	135073	981967	135253	982147	135420	982314
40	72	135074	981968	135254	982148	135421	982315
50	72	135075	981969	135255	982149	135422	982316
60	72	135076	981970	135256	982150	135423	982317
63	72	135077	981971	135257	982151	135424	982318

Icn=4500A

★ eB, 3P



In (A)	CTN	Order Code					
		Curve B		Curve C		Curve D	
		Standard	RoHS	Standard	RoHS	Standard	RoHS
1	48	135107	982001	135287	982181	135441	982335
2	48	135108	982002	135288	982182	135442	982336
3	48	135109	982003	135289	982183	135443	982337
4	48	135110	982004	135290	982184	135444	982338
5	48	135111	982005	135291	982185	135445	982339
6	48	135112	982006	135292	982186	135446	982340
10	48	135113	982007	135293	982187	135447	982341
15	48	135114	982008	135294	982188	135448	982342
16	48	135115	982009	135295	982189	135449	982343
20	48	135116	982010	135296	982190	135450	982344
25	48	135117	982011	135297	982191	135451	982345
32	48	135118	982012	135298	982192	135452	982346
40	48	135119	982013	135299	982193	135453	982347
50	48	135120	982014	135300	982194	135454	982348
60	48	135121	982015	135301	982195	135455	982349
63	48	135122	982016	135302	982196	135456	982350

Icn=4500A

★ eB, 4P



In (A)	CTN	Order Code					
		Curve B		Curve C		Curve D	
		Standard	RoHS	Standard	RoHS	Standard	RoHS
1	36	135152	982046	135332	982226	135473	982367
2	36	135153	982047	135333	982227	135474	982368
3	36	135154	982048	135334	982228	135475	982369
4	36	135155	982049	135335	982229	135476	982370
5	36	135156	982050	135336	982230	135477	982371
6	36	135157	982051	135337	982231	135478	982372
10	36	135158	982052	135338	982232	135479	982373
15	36	135159	982053	135339	982233	135480	982374
16	36	135160	982054	135340	982234	135481	982375
20	36	135161	982055	135341	982235	135482	982376
25	36	135162	982056	135342	982236	135483	982377
32	36	135163	982057	135343	982237	135484	982378
40	36	135164	982058	135344	982238	135485	982379
50	36	135165	982059	135345	982239	135486	982380
60	36	135166	982060	135346	982240	135487	982381
63	36	135167	982061	135347	982241	135488	982382

2.2 IEC/EN 60947-2
Ics=3kA

★ eBC, 1P



In (A)	CTN	Standard	RoHS
1	144	139320	985484
2	144	139321	985485
3	144	139322	985486
4	144	139323	985487
6	144	139324	985488
10	144	139325	985489
16	144	139326	985490
20	144	139327	985491
25	144	139328	985492
32	144	139329	985493
40	144	139330	985494
50	144	139331	985495
60	144	139332	985496
63	144	139333	985497

Ics=3kA

★ eBC, 2P



In (A)	CTN	Standard	RoHS
1	72	139334	985498
2	72	139335	985499
3	72	139336	985500
4	72	139337	985501
6	72	139338	985502
10	72	139339	985503
16	72	139340	985504
20	72	139341	985505
25	72	139342	985506
32	72	139343	985507
40	72	139344	985508
50	72	139345	985509
60	72	139346	985510
63	72	139347	985511

Ics=3kA

★ eBC, 3P



In (A)	CTN	Standard	RoHS
1	48	139348	985512
2	48	139349	985513
3	48	139350	985514
4	48	139351	985515
6	48	139352	985516
10	48	139353	985517
16	48	139354	985518
20	48	139355	985519
25	48	139356	985520
32	48	139357	985521
40	48	139358	985522
50	48	139359	985523
60	48	139360	985524
63	48	139361	985525

Ics=3kA

★ eBC, 4P



In (A)	CTN	Standard	RoHS
1	36	139362	985526
2	36	139363	985527
3	36	139364	985528
4	36	139365	985529
6	36	139366	985530
10	36	139367	985531
16	36	139368	985532
20	36	139369	985533
25	36	139370	985534
32	36	139371	985535
40	36	139372	985536
50	36	139373	985537
60	36	139374	985538
63	36	139375	985539

3. Technical data

3.1 Curves

0BC 0B 0BG is of high current limiting performance to limit the destruction energy due to short circuit to the greatest extent.

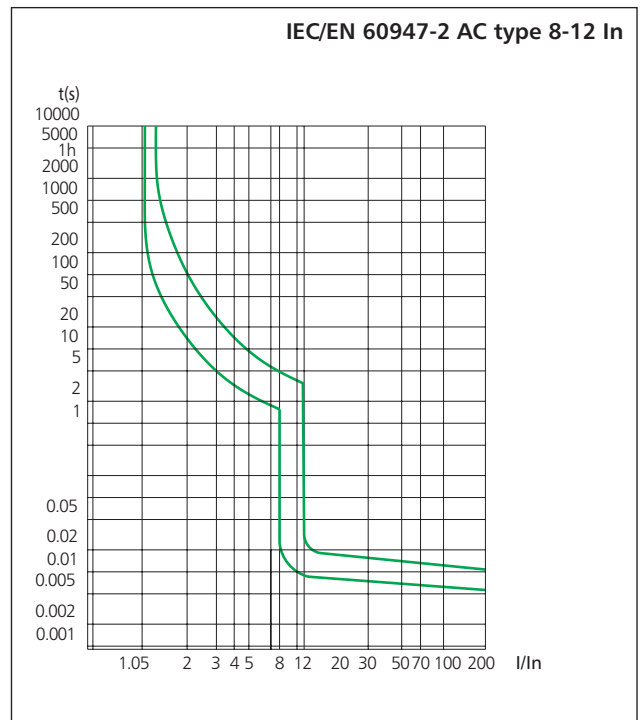
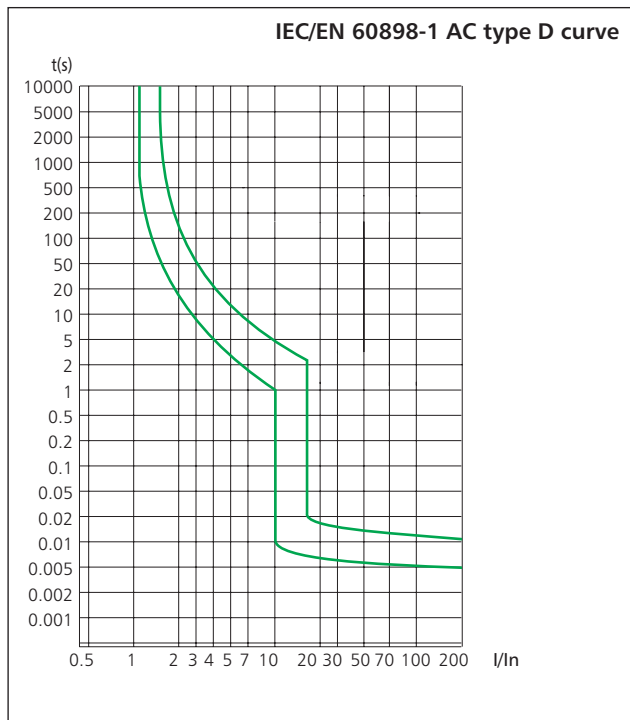
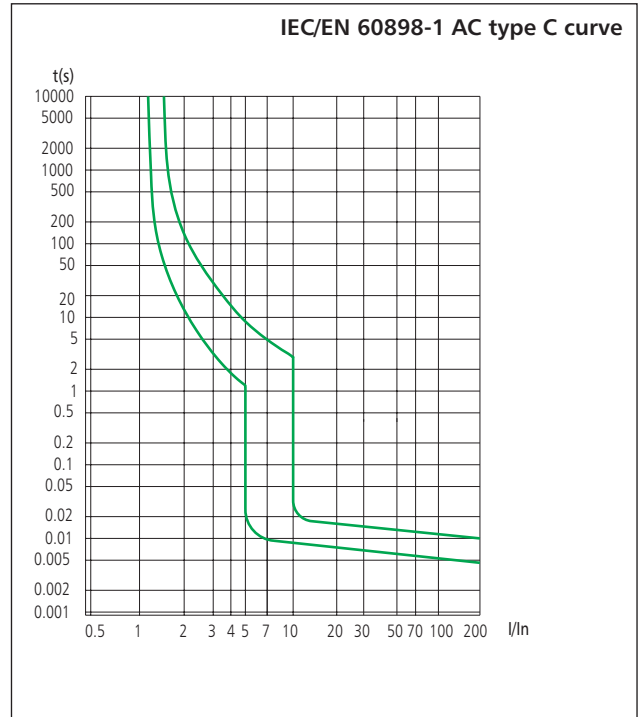
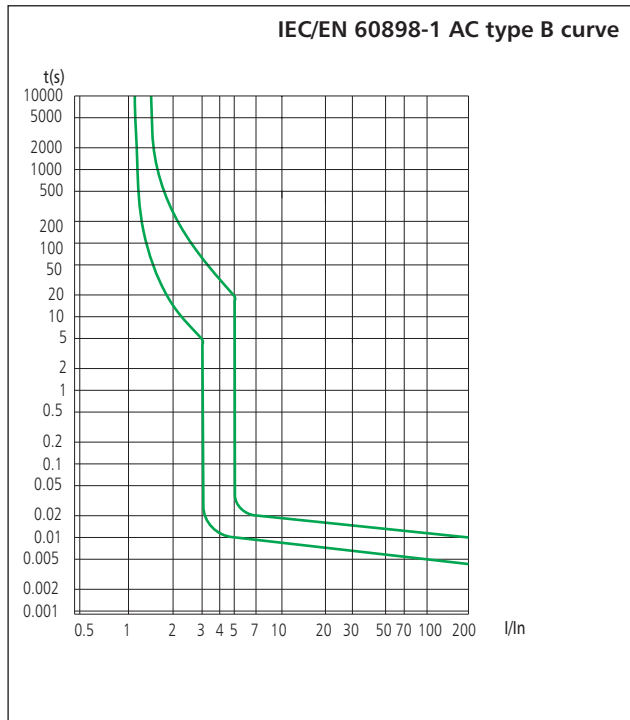

3.2

	Standard		IEC/EN 60898-1	IEC/EN 60947-2
Electrical features	Rated current In	A	1, 2, 3, 4, 6, 10, 15, 16, 20, 25, 32, 40, 50, 63	
	Poles		1P, 2P, 3P, 4P	
	Rated voltage Ue	V	230/400~240/415	
	Insulation voltage Ui	V	500	
	Rated frequency	Hz	50/60	
	Rated breaking capacity	kA	3 (1~63A) eBC 4.5 (1~63A) eB 6 (1~40A) eBG	
	Rated impulse withstand voltage(1.2/50) Uimp	V	4000	
	Dielectric test voltage at ind. Freq. for 1 min	kV	2	
	Pollution degree		2	
Thermo-magnetic release characteristic		B, C, D	8-12In	
Mechanical features	Electrical life		4,000	
	Mechanical life		10,000	
	Protection degree		IP20	
	Reference temperature for setting of thermal element	°C	30	
	Ambient temperature (with daily average ≤35°C)	°C	-5...+40(Special application please refer to P20 for temperature compensation correction)	
	Storage temperature	°C	-25...+70	
Installation	Terminal connection type		Cable/Pin-type busbar	
	Terminal size top/bottom for cable	mm ²	1~25	
		AWG	17~3	
	Terminal size top/bottom for busbar	mm ²	1~10	
		AWG	17~7	
	Tightening torque	N*m	2	
		In-lbs.	18	
Mounting		On DIN rail EN 60715 (35mm) by means of fast clip device		
Connection		From top and bottom		

3.3 Temperature derating

The maximum permissible current in a circuit breaker depends on the ambient temperature where the circuit breaker is placed. Ambient temperature is the temperature inside the enclosure or switchboard in which the circuit breakers are installed.
The reference temperature is 30°C

Rated current In (A)	Temperature compensation coefficient under various operational temperature								
	-10°C	0°C	10°C	20°C	30°C	40°C	50°C	55°C	60°C
1~6	1.20	1.14	1.09	1.05	1.00	0.96	0.80	0.75	0.70
10~32	1.18	1.12	1.08	1.04	1.00	0.96	0.92	0.88	0.84
40~60	1.16	1.12	1.07	1.03	1.00	0.97	0.87	0.83	0.80

4. Overall and mounting dimensions (mm)

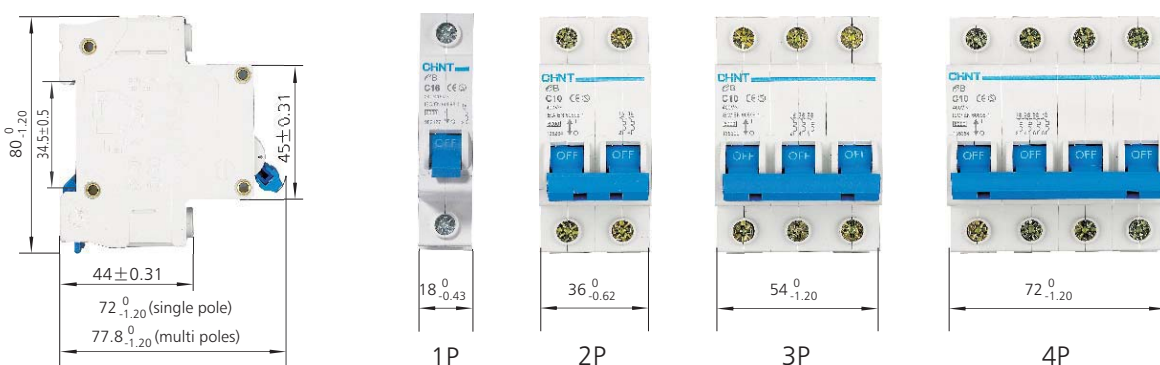



UB Miniature Circuit Breaker

1. General

1.1 Function

protection of circuits against short-circuit currents,
protection of circuits against overload currents,
switch,
isolation.

1.2 Selection

Technical data of the network at the point considered:
the earthing systems (TNS, TNC),
short-circuit current at the circuit-breaker installation point,
which must always be less than the breaking capacity of
this device,

Network normal voltage.

Tripping curves:

B curve (3-5I_n)

protection for people and big length cables in TN and IT
systems.

C curve (5-10I_n)

protection for resistive and inductive loads with low inrush
current.

1.3 Approvals and certificates

Detailed information, please refer to Certificates Table
on the last page.



2. Ordering information

Curve B, C

Icn=6000A (In: 6~40A)

★ UB, 1P



In (A)	CTN	Order Code	
		Curve B	Curve C
		RoHS	RoHS
6	144	984713	984728
10	144	984714	984729
13	144	984715	984730
15	144	984716	984731
16	144	984717	984732
20	144	984718	984733
25	144	984719	984734
32	144	984720	984735
40	144	984721	984736

Curve B, C

Icn=6000A (In: 6~40A)

★ UB, 2P



In (A)	CTN	Order Code	
		Curve B	Curve C
		RoHS	RoHS
6	72	984758	984773
10	72	984759	984774
13	72	984760	984775
15	72	984761	984776
16	72	984762	984777
20	72	984763	984778
25	72	984764	984779
32	72	984765	984780
40	72	984766	984781

Curve B, C

Icn=6000A (In: 6~40A)

★ UB, 3P



In (A)	CTN	Order Code	
		Curve B	Curve C
		RoHS	RoHS
6	48	984803	984818
10	48	984804	984819
13	48	984805	984820
15	48	984806	984821
16	48	984807	984822
20	48	984808	984823
25	48	984809	984824
32	48	984810	984825
40	48	984811	984826

Curve B, C

Icn=6000A (In: 6~40A)

★ UB, 4P



In (A)	CTN	Order Code	
		Curve B	Curve C
		RoHS	RoHS
6	36	984848	984863
10	36	984849	984864
13	36	984850	984865
15	36	984851	984866
16	36	984852	984867
20	36	984853	984868
25	36	984854	984869
32	36	984855	984870
40	36	984856	984871

3. Technical data

3.1 Curves

UB MCB is of high current limiting performance to limit the destruction energy due to short circuit to the greatest extent.

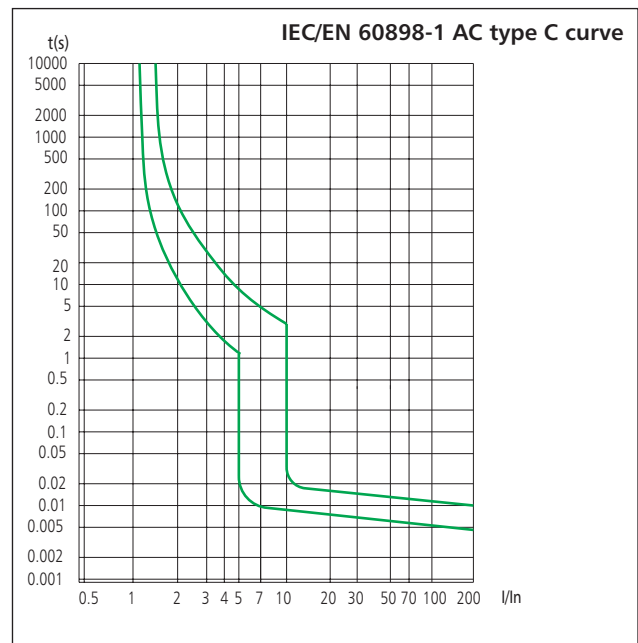
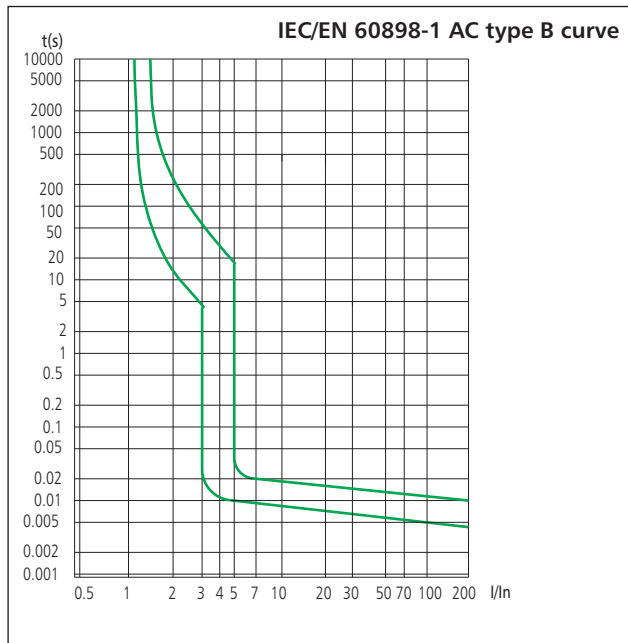

3.2

	Standard		IEC/EN 60898-1
Electrical features	Rated current In	A	6, 10, 13, 16, 20, 25, 32, 40
	Poles		1P, 2P, 3P, 4P
	Rated voltage Ue	V	230/400~240/415
	Insulation voltage Ui	V	500
	Rated frequency		50/60Hz
	Rated breaking capacity	A	6000
	Rated impulse withstand voltage(1.2/50) Uimp	V	4000
	Dielectric test voltage at ind. Freq. for 1 min	kV	2
	Pollution degree		2
	Thermo-magnetic release characteristic		B, C
Mechanical features	Electrical life		4, 000
	Mechanical life		10, 000
	Protection degree		IP20
	Reference temperature for setting of thermal element	°C	30
	Ambient temperature (with daily average ≤35°C)	°C	-5...+40(Special application please refer to P24 for temperature compensation correction)
	Storage temperature	°C	-25...+70
Installation	Terminal connection type		Cable/U-type busbar/Pin-type busbar
	Terminal size top/bottom for cable	mm ²	1~25
		AWG	17~3
	Terminal size top/bottom for busbar	mm ²	1~10
		AWG	17~7
	Tightening torque	N*m	2
		In-lbs.	18
Mounting		On DIN rail EN 60715 (35mm) by means of fast clip device	
Connection		From top and bottom	

3.3 Temperature derating

The maximum permissible current in a circuit breaker depends on the ambient temperature where the circuit breaker is placed. Ambient temperature is the temperature inside the enclosure or switchboard in which the circuit breakers are installed.

The reference temperature is 30°C

Rated current In (A)	Temperature compensation coefficient under various operational temperature									
	-10°C	0°C	10°C	20°C	30°C	40°C	50°C	55°C	60°C	
6	1.20	1.14	1.09	1.05	1.00	0.96	0.80	0.75	0.70	
10~32	1.18	1.12	1.08	1.04	1.00	0.96	0.92	0.88	0.84	
40	1.16	1.12	1.07	1.03	1.00	0.97	0.87	0.83	0.80	

4. Overall and mounting dimensions (mm)

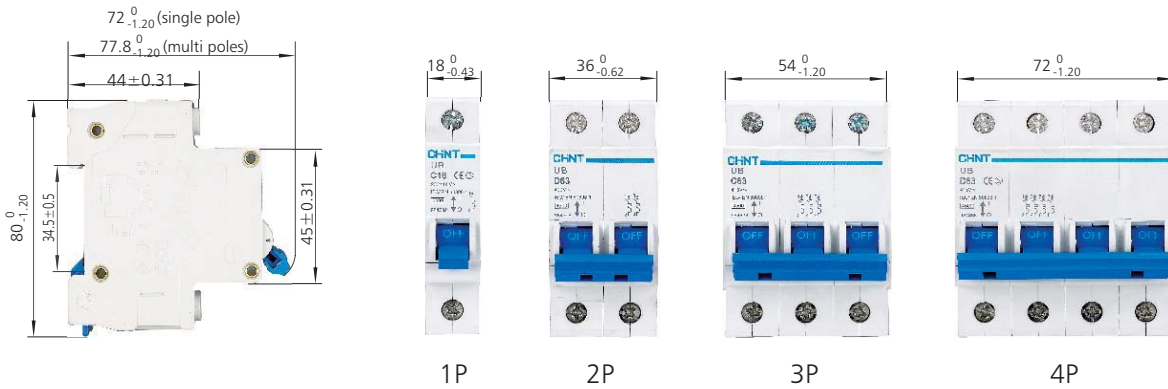



DZ158 Moulded Case Circuit Breaker

1. General

1.1 Function

protection of circuits against short-circuit currents,
protection of circuits against overload currents,
switch,
isolation.

1.2 Selection

Technical data of the network at the point considered:
the earthing systems (TNS, TNC),
short-circuit current at the circuit-breaker installation point,
which must always be less than the breaking capacity of
this device,
Network normal voltage.

1.3 Approvals and certificates

Detailed information, please refer to Certificates Table
on the last page.

CE

TUV

S

005

PC

RCC

SAA

2. Ordering information

Icu=6kA

★ DZ158, 1P



In (A)	Icn (kA)	CTN	Order Code	
			Standard	RoHS
63	6	108	134001	970001
80	6	108	134002	970002
100	6	108	134003	970003
125	6	108	134025	979476

Icu=6kA

★ DZ158, 2P



In (A)	Icn (kA)	CTN	Order Code	
			Standard	RoHS
63	6	54	134004	970004
80	6	54	134005	970005
100	6	54	134006	970006
125	6	54	134026	979477

Icu=6kA

★ DZ158, 3P



In (A)	Icn (kA)	CTN	Order Code	
			Standard	RoHS
63	6	36	134007	970007
80	6	36	134008	970008
100	6	36	134009	970009
125	6	36	134027	979478

Icu=6kA

★ DZ158, 4P



In (A)	Icn (kA)	CTN	Order Code	
			Standard	RoHS
63	6	27	134010	970010
80	6	27	134011	970011
100	6	27	134012	970012
125	6	27	134028	979479

Icu=10kA

★ DZ158, 1P



In (A)	Icn (kA)	CTN	Order Code	
			Standard	RoHS
63	10	108	134013	978979
80	10	108	134014	978980
100	10	108	134015	978981
125	10	108	-	985594

Icu=10kA

★ DZ158, 2P



In (A)	Icn (kA)	CTN	Order Code	
			Standard	RoHS
63	10	54	134016	978982
80	10	54	134017	978983
100	10	54	134018	978984
125	10	54	-	985595

Icu=10kA

★ DZ158, 3P



In (A)	Icn (kA)	CTN	Order Code	
			Standard	RoHS
63	10	36	134019	978985
80	10	36	134020	978986
100	10	36	134021	978987
125	10	36	-	985596

Icu=10kA

★ DZ158, 4P



In (A)	Icn (kA)	CTN	Order Code	
			Standard	RoHS
63	10	27	134022	978988
80	10	27	134023	978989
100	10	27	134024	978990
125	10	27	-	985597

3. Technical data

3.1 Curves

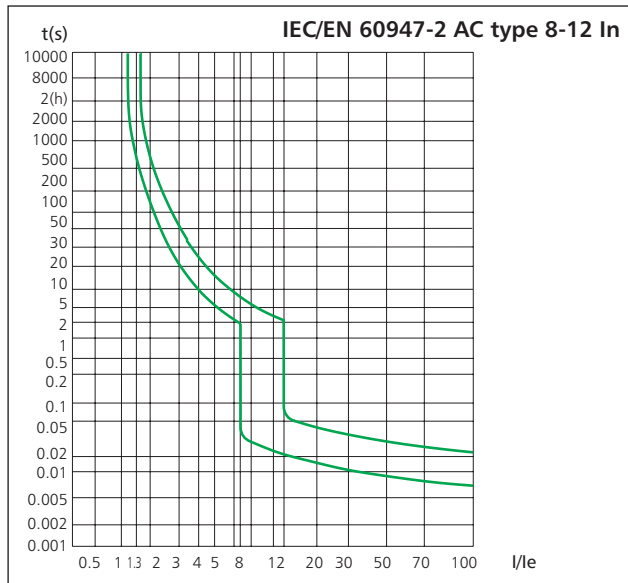

3.2

	Standard		IEC/EN 60947-2
Electrical features	Rated current In	A	63, 80, 100, 125
	Poles		1P, 2P, 3P, 4P
	Rated voltage Ue	V	230/400~240/415
	Insulation voltage Ui	V	500
	Rated frequency	Hz	50
	Rated breaking capacity	kA	6/10
	Rated impulse withstand voltage(1.2/50) Uimp	V	4000
	Dielectric test voltage at ind. Freq. for 1 min	kV	2.0
	Pollution degree		3
	Thermo-magnetic release characteristic		8-12In
Mechanical features	Electrical life		1,500 (In=63A, 80A, 100A) 1,000 (In=125A)
	Mechanical life		8,500 (In=63A, 80A, 100A) 7,000 (In=125A)
	Contact position indicator		Yes
	Protection degree		IP20
	Reference temperature for setting of thermal element	°C	30
	Ambient temperature (with daily average ≤35°C)	°C	-5...+40(Special application please refer to P28 for temperature compensation correction)
Storage temperature	°C	-25...+70	
Installation	Terminal connection type		Cable/Pin-type busbar
	Terminal size top/bottom for cable	mm ²	16~50
		AWG	6-1/0
	Terminal size top/bottom for busbar	mm ²	16~35
		AWG	6-2
	Tightening torque	N*m	3.5
In-lbs.		31	
Mounting		On DIN rail EN 60715 (35mm) by means of fast clip device	
Connection		From top	
Combination with accessories	Auxiliary contact		Yes

3.3 Temperature derating

The maximum permissible current in a circuit breaker depends on the ambient temperature where the circuit breaker is placed. Ambient temperature is the temperature inside the enclosure or switchboard in which the circuit breakers are installed.
The reference temperature is 30°C

Rated current In (A)	Temperature compensation coefficient under various operational temperature							
	-10°C	0°C	10°C	20°C	30°C	40°C	50°C	60°C
63	1.275	1.215	1.15	1.075	1.00	0.915	0.825	0.735
80	1.27	1.205	1.135	1.07	1.00	0.925	0.845	0.755
100	1.275	1.21	1.135	1.075	1.00	0.925	0.845	0.755
125	1.25	1.19	1.125	1.08	1.00	0.93	0.86	0.78

4. Overall and mounting dimensions (mm)

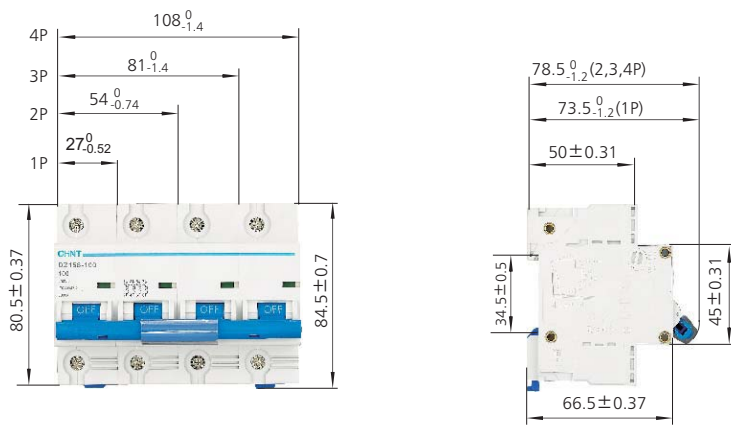



NBH8 Miniature Circuit Breaker

1. General

1.1 Function

protection of circuits against short-circuit currents,
protection of circuits against overload currents,
switch,
isolation.

1.2 Selection

Technical data of the network at the point considered:
the earthing systems (TNS, TNC),
short-circuit current at the circuit-breaker installation point,
which must always be less than the breaking capacity of
this device,

Network normal voltage.

Tripping curves:

B curve (3-5I_n)

protection for people and big length cables in TN and IT
systems.

C curve (5-10I_n)

protection for resistive and inductive loads with low inrush
current.

1.3 Approvals and certificates

Detailed information, please refer to Certificates Table
on the last page.



RCC

SAA

2. Ordering information

Icn=4500A

★ NBH8, 1P+N



Icn=6000A

★ NBH8, 1P+N



In (A)	CTN	Order Code			
		Curve B		Curve C	
		Standard	RoHS	Standard	RoHS
1	180	132100	972143	132111	972154
2	180	132101	972144	132112	972155
3	180	132102	972145	132113	972156
4	180	132103	972146	132114	972157
6	180	132104	972147	132115	972158
10	180	132105	972148	132116	972159
16	180	132106	972149	132117	972160
20	180	132107	972150	132118	972161
25	180	132108	972151	132119	972162
32	180	132109	972152	132120	972163
40	180	132110	972153	132121	972164

In (A)	CTN	Order Code			
		Curve B		Curve C	
		Standard	RoHS	Standard	RoHS
1	180	132122	983259	132133	983270
2	180	132123	983260	132134	983271
3	180	132124	983261	132135	983272
4	180	132125	983262	132136	983273
6	180	132126	983263	132137	983274
10	180	132127	983264	132138	983275
16	180	132128	983265	132139	983276
20	180	132129	983266	132140	983277
25	180	132130	983267	132141	983278
32	180	132131	983268	132142	983279
40	180	132132	983269	132143	983280

3. Technical data

3.1 Curves

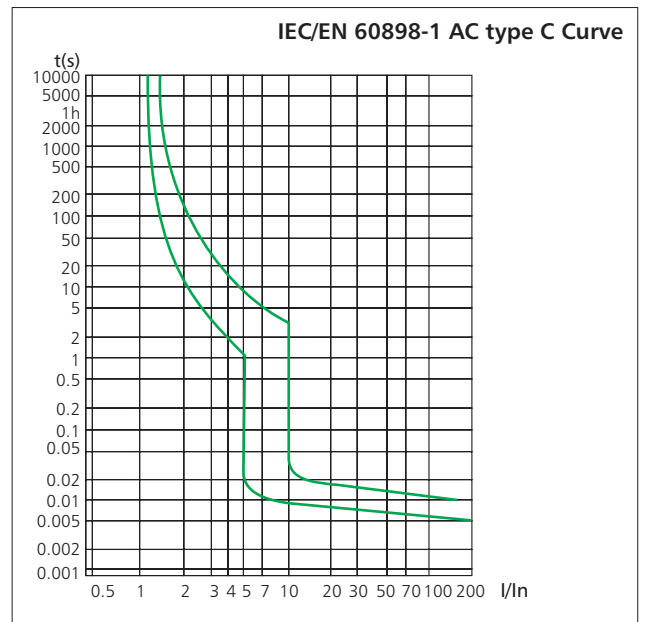
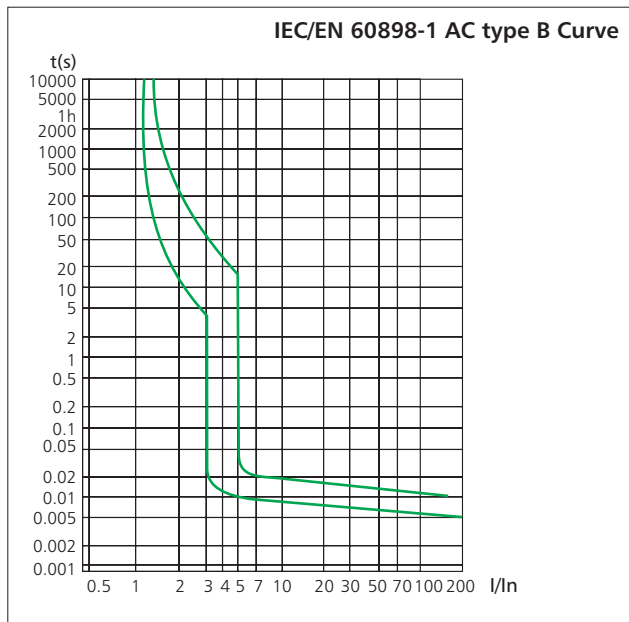

3.2

	Standard		IEC/EN 60898-1
Electrical features	Rated current In	A	1, 2, 3, 4, 6, 10, 16, 20, 25, 32, 40
	Poles		1P+N
	Rated voltage Ue	V	230/240
	Insulation voltage Ui	V	500
	Rated frequency	Hz	50/60
	Rated breaking capacity	A	4500/6000
	Rated impulse withstand voltage(1.2/50) Uimp	V	4000
	Dielectric test voltage at ind. Freq. for 1 min	kV	2
	Pollution degree		2
	Energy limiting class		3
Mechanical features	Electrical life		8, 000
	Mechanical life		20, 000
	Contact position indicator		Yes
	Protection degree		IP20
	Reference temperature for setting of thermal element	°C	30
	Ambient temperature (with daily average ≤ 35°C)	°C	-5...+40(Special application please refer to P29 for temperature compensation correction)
Storage temperature	°C	-25...+70	
Installation	Terminal connection type		Cable/Pin-type busbar
	Terminal size top/bottom for cable	mm ²	16
		AWG	18-5
	Terminal size top/bottom for busbar	mm ²	10
		AWG	18-8
	Tightening torque	N*m	2
		In-lbs.	18
Mounting		On DIN rail EN 60715 (35mm) by means of fast clip device	
Connection		From top and bottom	
Combination with accessories	Auxiliary contact		Yes
	Shunt release		Yes
	Under voltage release		Yes
	Alarm contact		Yes

3.3 Temperature derating

The maximum permissible current in a circuit breaker depends on the ambient temperature where the circuit breaker is placed. Ambient temperature is the temperature inside the enclosure or switchboard in which the circuit breakers are installed.

The reference temperature is 30°C

Temperature	-10°C	0°C	10°C	20°C	30°C	40°C	50°C	55°C	60°C
Temperature compensation coefficient	1.20	1.15	1.10	1.05	1.00	0.95	0.90	0.875	0.85

4. Overall and mounting dimensions (mm)

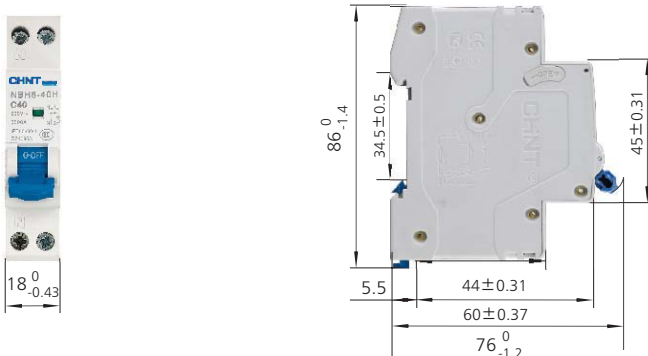



NL1 Residual Current Operated Circuit Breaker without over-current protection (Magnetic)

1. General

1.1 Function

Control electric circuits.

Protect people against indirect contacts and additional protection against direct contacts.

Protect installations against fire hazard due to insulation faults.

Residual current circuit breakers are used in housing, tertiary sector and industry.

1.2 Selection

Detectable wave form

AC class

Tripping is ensured for slowly increasing sinusoidal AC residual currents.

A class

Tripping is ensured for sinusoidal AC residual currents and for pulsed DC residual currents, whether applied suddenly or increasing slowly.

Tripping sensitivity

30mA - additional protection against direct contact.

100mA - co-ordinated with the earth system according to the formula $I_{\Delta n} < 50/R$, to provide protection against indirect contacts;

300mA - protection against indirect contacts, as well as fire hazard.

Tripping time

Instantaneous

It ensures instantaneous tripping (without time-delay).

Short time delay

It ensures any tripping at least 10ms.

Selective

It ensures total discrimination with a nonselective RCD placed downstream.

1.3 Approvals and certificates

Detailed information, please refer to Certificates Table on the last page.



RCC

SAA

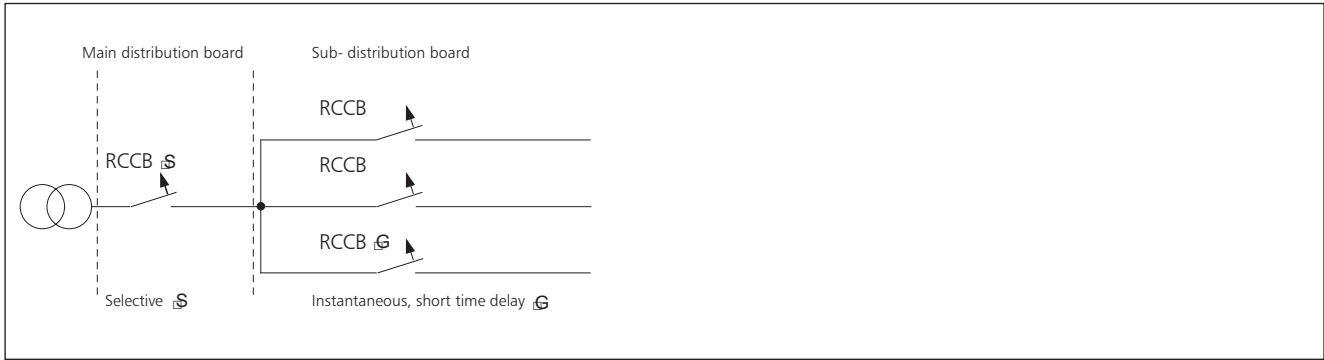

2. Ordering information

I Δ c=6000A

★ NL1-63, 2P



In (A)	I Δ n (mA)	CTN	Order Code	
			A Type	AC Type
25	30	90	972165	972174
25	100	90	972166	972175
25	300	90	972167	972176
40	30	90	972168	972177
40	100	90	972169	972178
40	300	90	972170	972179
63	30	90	972171	972180
63	100	90	972172	972181
63	300	90	972173	972182

I Δ c=6000A

★ NL1-63, 4P



In (A)	I Δ n (mA)	CTN	Order Code	
			A Type	AC Type
25	30	45	972183	972192
25	100	45	972184	972193
25	300	45	972185	972194
40	30	45	972186	972195
40	100	45	972187	972196
40	300	45	972188	972197
63	30	45	972189	972198
63	100	45	972190	972199
63	300	45	972191	972200

I Δ c=10000A

★ NL1-63, 2P



In (A)	I Δ n (mA)	CTN	Order Code	
			A Type	AC Type
25	30	90	984889	984904
25	100	90	984890	984905
25	300	90	984891	984906
40	30	90	984892	984907
40	100	90	984893	984908
40	300	90	984894	984909
63	30	90	984895	984910
63	100	90	984896	984911
63	300	90	984897	984912

I Δ c=10000A

★ NL1-63, 4P



In (A)	I Δ n (mA)	CTN	Order Code	
			A Type	AC Type
25	30	45	984919	984934
25	100	45	984920	984935
25	300	45	984921	984936
40	30	45	984922	984937
40	100	45	984923	984938
40	300	45	984924	984939
63	30	45	984925	984940
63	100	45	984926	984941
63	300	45	984927	984942

$I_{\Delta c}=6000A$

★ NL1-63, 2P



In (A)	$I_{\Delta n}$ (mA)	CTN	Order Code	
			A-G Type	AC-G Type
25	30	90	986478	986442
25	100	90	986480	986444
25	300	90	986482	986446
40	30	90	986484	986448
40	100	90	986486	986450
40	300	90	986488	986452
63	30	90	986490	986454
63	100	90	986492	986456
63	300	90	986494	986458

$I_{\Delta c}=6000A$

★ NL1-63, 4P



In (A)	$I_{\Delta n}$ (mA)	CTN	Order Code	
			A-G Type	AC-G Type
25	30	45	986496	986460
25	100	45	986498	986462
25	300	45	986500	986464
40	30	45	986502	986466
40	100	45	986504	986468
40	300	45	986506	986470
63	30	45	986508	986472
63	100	45	986510	986474
63	300	45	986512	986476

$I_{\Delta c}=10000A$

★ NL1-100, 2P



In (A)	$I_{\Delta n}$ (mA)	CTN	Order Code	
			A-S Type	AC-S Type
63	100	90	985555	985541
63	300	90	985556	985542
80	100	90	985557	985543
80	300	90	985558	985544
100	100	90	985559	985545
100	300	90	985560	985546

$I_{\Delta c}=10000A$

★ NL1-100, 4P



In (A)	$I_{\Delta n}$ (mA)	CTN	Order Code	
			A-S Type	AC-S Type
63	100	45	985561	985547
63	300	45	985562	985548
80	100	45	985563	985549
80	300	45	985564	985550
100	100	45	985565	985551
100	300	45	985566	985552

3. Technical data

	Standard		IEC/EN 61008-1
Electrical features	Type (wave form of the earth leakage sensed)		AC, A, AC-G, A-G, AC-S, A-S
	Rated current I _n	A	25, 40, 63, 80, 100
	Poles		2P, 4P
	Rated voltage U _e	V	230/400~240/415
	Rated sensitivity I _{Δn}	A	0.03, 0.1, 0.3
	Insulation voltage U _i	V	500
	Rated residual making and breaking capacity I _{Δm}	A	500 (I _n =25A/40A), 1000(I _n =30A/100A)
			630 (I _n =63A)
	Short-circuit current I _{nc} =I _{Δc}	A	6000/10000
	SCPD fuse	A	 10000
	break time under I _{Δn}	S	≤0.1(Normal type), 10ms~30ms(G type). 150ms~500ms(S type)
	Rated frequency	Hz	50/60
	Rated impulse withstand voltage(1.2/50) U _{imp}	V	6000
	Dielectric test voltage at ind. Freq. for 1 min	kV	2.5
Pollution degree		2	
Mechanical features	Electrical life		2, 000
	Mechanical life		2, 000
	Fault current indicator		Yes
	Protection degree		IP20
	Ambient temperature (with daily average ≤35°C)	°C	-5...+40
	Storage temperature	°C	-25...+70
Installation	Terminal connection type		Cable/U-type busbar/Pin-type busbar
	Terminal size top/bottom for cable	mm ²	25/35
		AWG	18-3/18-2
	Terminal size top/bottom for busbar	mm ²	10/16
		AWG	18-8/18-5
	Tightening torque	N*m	2.5
		In-lbs.	22
Mounting		On DIN rail EN 60715 (35mm) by means of fast clip device	
Connection		From top and bottom	

4. Overall and mounting dimensions (mm)

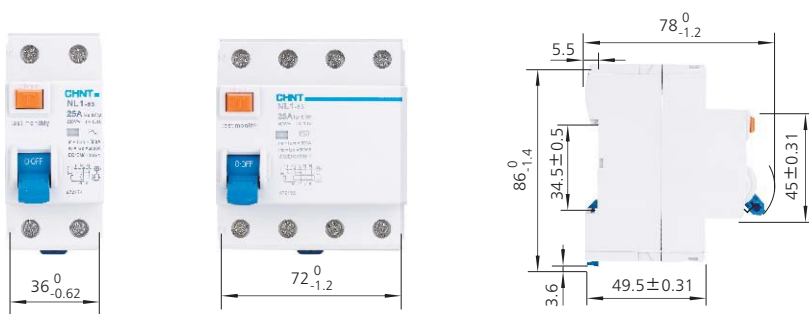



NB1L Residual Current Operated Circuit Breaker with over-current protection (Magnetic)

1. General

1.1 Function

Personnel and fire protection: Cable and line protection against overload and short-circuits.

1.2 Selection

Rated residual operating current

$I_{\Delta n} \leq 30$ mA: additional protection in the case of direct contact.

$I_{\Delta n} \leq 300$ mA: preventative fire protection in the case of ground fault currents.

Tripping class

AC class

Tripping is ensured for sinusoidal, alternating currents, whether they be quickly applied or slowly increase.

A class

Tripping is ensured for sinusoidal, alternating residual currents as well as for pulsed DC residual currents, whether they be quickly applied or slowly increase.

Tripping curve

B curve (3-5 I_n) protection and control of the circuits against overloads and short-circuits; protection for people and big length cables in TN and IT systems.

C curve (5-10 I_n) protection and control of the circuits against overloads and short-circuits; protection for resistive and inductive loads with low inrush current.

1.3 Approvals and certificates

Detailed information, please refer to Certificates Table on the last page.



SAA

2. Ordering information

2.1 Combined

1~25A, A Type, I_{cn}=6000A, 36mm

★ NB1L, 1P+N



In (A)	I _{Δn} (mA)	CTN	Order Code	
			Curve B	Curve C
			RoHS	RoHS
1	30	90	982383	982407
2	30	90	982384	982408
3	30	90	982385	982409
4	30	90	982386	982410
6	30	90	982387	982411
10	30	90	982388	982412
13	30	90	982389	982413
16	30	90	982390	982414
20	30	90	982391	982415
25	30	90	982392	982416

6~40A, AC Type, I_{cn}=10000A, 36mm

★ NB1L, 1P+N



In (A)	I _{Δn} (mA)	CTN	Order Code	
			Curve B	Curve C
			RoHS	RoHS
6	30	72	986824	986848
6	100	72	986872	986896
6	300	72	986920	986944
10	30	72	986825	986849
10	100	72	986873	986897
10	300	72	986921	986945
13	30	72	986826	986850
13	100	72	986874	986898
13	300	72	986922	986946
16	30	72	986827	986851
16	100	72	986875	986899
16	300	72	986923	986947
20	30	72	986828	986852
20	100	72	986876	986900
20	300	72	986924	986948
25	30	72	986829	986853
25	100	72	986877	986901
25	300	72	986925	986949
32	30	72	986830	986854
32	100	72	986878	986902
32	300	72	986926	986950
40	30	72	986831	986855
40	100	72	986879	986903
40	300	72	986927	986951

6~40A, A Type, I_{cn}=10000A, 36mm

★ NB1L, 1P+N



In (A)	I _{Δn} (mA)	CTN	Order Code	
			Curve B	Curve C
			RoHS	RoHS
6	30	72	982435	982459
6	100	72	986968	986980
6	300	72	986992	987016
10	30	72	982436	982460
10	100	72	986969	986981
10	300	72	986993	987017
13	30	72	982437	982461
13	100	72	986970	986982
13	300	72	986994	987018
16	30	72	982438	982462
16	100	72	986971	986983
16	300	72	986995	987019
20	30	72	982439	982463
20	100	72	986972	986984
20	300	72	986996	987020
25	30	72	982440	982464
25	100	72	986973	986985
25	300	72	986997	987021
32	30	72	982441	982465
32	100	72	986974	986986
32	300	72	986998	987022
40	30	72	982442	982466
40	100	72	986975	986987
40	300	72	986999	987023

6-40A, A Type, Icn=10000A, 54mm

★ NB1L, 2P



6-40A, AC Type, Icn=10000A, 54mm

★ NB1L, 2P



In (A)	I Δ n (mA)	CTN	Order Code	
			Curve B	Curve C
			RoHS	RoHS
6	30	60	982447	982471
6	100	60	986759	986771
6	300	60	986177	986189
10	30	60	982448	982472
10	100	60	986760	986772
10	300	60	986178	986190
13	30	60	982449	982473
13	100	60	986761	986773
13	300	60	986179	986191
16	30	60	982450	982474
16	100	60	986762	986774
16	300	60	986180	986192
20	30	60	982451	982475
20	100	60	986763	986775
20	300	60	986181	986193
25	30	60	982452	982476
25	100	60	986764	986776
25	300	60	986182	986194
32	30	60	982453	982477
32	100	60	986765	986777
32	300	60	986183	986195
40	30	60	982454	982478
40	100	60	986766	986778
40	300	60	986184	986196

In (A)	I Δ n (mA)	CTN	Order Code	
			Curve B	Curve C
			RoHS	RoHS
6	30	60	986836	986860
6	100	60	986884	986908
6	300	60	986932	986956
10	30	60	986837	986861
10	100	60	986885	986909
10	300	60	986933	986957
13	30	60	986838	986862
13	100	60	986886	986910
13	300	60	986934	986958
16	30	60	986839	986863
16	100	60	986887	986911
16	300	60	986935	986959
20	30	60	986840	986864
20	100	60	986888	986912
20	300	60	986936	986960
25	30	60	986841	986865
25	100	60	986889	986913
25	300	60	986937	986961
32	30	60	986842	986866
32	100	60	986890	986914
32	300	60	986938	986962
40	30	60	986843	986867
40	100	60	986891	986915
40	300	60	986939	986963

2.2 MCB+add-on RCCB block

1~40A, AC type, Icn=6000A

★ NB1L-40, 1P+N



1~40A, AC type, Icn=6000A

★ NB1L-40, 2P



In (A)	I _{Δn} (mA)	CTN	Order Code			
			Curve B		Curve C	
			Standard	RoHS	Standard	RoHS
1	30	80	142001	983290	142166	971948
1	100	80	142002	983291	142167	971949
1	300	80	142003	983292	142168	971950
2	30	80	142004	983293	142169	971951
2	100	80	142005	983294	142170	971952
2	300	80	142006	983295	142171	971953
3	30	80	142007	983296	142172	971954
3	100	80	142008	983297	142173	971955
3	300	80	142009	983298	142174	971956
4	30	80	142010	983299	142175	971957
4	100	80	142011	983300	142176	971958
4	300	80	142012	983301	142177	971959
6	30	80	142013	983302	142178	971960
6	100	80	142014	983303	142179	971961
6	300	80	142015	983304	142180	971962
10	30	80	142016	983305	142181	971963
10	100	80	142017	983306	142182	971964
10	300	80	142018	983307	142183	971965
16	30	80	142019	983308	142184	971966
16	100	80	142020	983309	142185	971967
16	300	80	142021	983310	142186	971968
20	30	80	142022	983311	142187	971969
20	100	80	142023	983312	142188	971970
20	300	80	142024	983313	142189	971971
25	30	80	142025	983314	142190	971972
25	100	80	142026	983315	142191	971973
25	300	80	142027	983316	142192	971974
32	30	80	142028	983317	142193	971975
32	100	80	142029	983318	142194	971976
32	300	80	142030	983319	142195	971977
40	30	80	142031	983320	142196	971978
40	100	80	142032	983321	142197	971979
40	300	80	142033	983322	142198	971980

In (A)	I _{Δn} (mA)	CTN	Order Code			
			Curve B		Curve C	
			Standard	RoHS	Standard	RoHS
1	30	42	142034	983323	142199	971981
1	100	42	142035	983324	142200	971982
1	300	42	142036	983325	142201	971983
2	30	42	142037	983326	142202	971984
2	100	42	142038	983327	142203	971985
2	300	42	142039	983328	142204	971986
3	30	42	142040	983329	142205	971987
3	100	42	142041	983330	142206	971988
3	300	42	142042	983331	142207	971989
4	30	42	142043	983332	142208	971990
4	100	42	142044	983333	142209	971991
4	300	42	142045	983334	142210	971992
6	30	42	142046	983335	142211	971993
6	100	42	142047	983336	142212	971994
6	300	42	142048	983337	142213	971995
10	30	42	142049	983338	142214	971996
10	100	42	142050	983339	142215	971997
10	300	42	142051	983340	142216	971998
16	30	42	142052	983341	142217	971999
16	100	42	142053	983342	142218	972000
16	300	42	142054	983343	142219	972001
20	30	42	142055	983344	142220	972002
20	100	42	142056	983345	142221	972003
20	300	42	142057	983346	142222	972004
25	30	42	142058	983347	142223	972005
25	100	42	142059	983348	142224	972006
25	300	42	142060	983349	142225	972007
32	30	42	142061	983350	142226	972008
32	100	42	142062	983351	142227	972009
32	300	42	142063	983352	142228	972010
40	30	42	142064	983353	142229	972011
40	100	42	142065	983354	142230	972012
40	300	42	142066	983355	142231	972013

1~40A, AC type, Icn=6000A

★ NB1L-40, 3P



In (A)	I Δ n (mA)	CTN	Order Code			
			Curve B		Curve C	
			Standard	RoHS	Standard	RoHS
1	30	32	142067	983356	142232	972014
1	100	32	142068	983357	142233	972015
1	300	32	142069	983358	142234	972016
2	30	32	142070	983359	142235	972017
2	100	32	142071	983360	142236	972018
2	300	32	142072	983361	142237	972019
3	30	32	142073	983362	142238	972020
3	100	32	142074	983363	142239	972021
3	300	32	142075	983364	142240	972022
4	30	32	142076	983365	142241	972023
4	100	32	142077	983366	142242	972024
4	300	32	142078	983367	142243	972025
6	30	32	142079	983368	142244	972026
6	100	32	142080	983369	142245	972027
6	300	32	142081	983370	142246	972028
10	30	32	142082	983371	142247	972029
10	100	32	142083	983372	142248	972030
10	300	32	142084	983373	142249	972031
16	30	32	142085	983374	142250	972032
16	100	32	142086	983375	142251	972033
16	300	32	142087	983376	142252	972034
20	30	32	142088	983377	142253	972035
20	100	32	142089	983378	142254	972036
20	300	32	142090	983379	142255	972037
25	30	32	142091	983380	142256	972038
25	100	32	142092	983381	142257	972039
25	300	32	142093	983382	142258	972040
32	30	32	142094	983383	142259	972041
32	100	32	142095	983384	142260	972042
32	300	32	142096	983385	142261	972043
40	30	32	142097	983386	142262	972044
40	100	32	142098	983387	142263	972045
40	300	32	142099	983388	142264	972046

1~40A, AC type, Icn=6000A

★ NB1L-40, 3P+N



In (A)	I Δ n (mA)	CTN	Order Code			
			Curve B		Curve C	
			Standard	RoHS	Standard	RoHS
1	30	32	142100	983389	142265	972047
1	100	32	142101	983390	142266	972048
1	300	32	142102	983391	142267	972049
2	30	32	142103	983392	142268	972050
2	100	32	142104	983393	142269	972051
2	300	32	142105	983394	142270	972052
3	30	32	142106	983395	142271	972053
3	100	32	142107	983396	142272	972054
3	300	32	142108	983397	142273	972055
4	30	32	142109	983398	142274	972056
4	100	32	142110	983399	142275	972057
4	300	32	142111	983400	142276	972058
6	30	32	142112	983401	142277	972059
6	100	32	142113	983402	142278	972060
6	300	32	142114	983403	142279	972061
10	30	32	142115	983404	142280	972062
10	100	32	142116	983405	142281	972063
10	300	32	142117	983406	142282	972064
16	30	32	142118	983407	142283	972065
16	100	32	142119	983408	142284	972066
16	300	32	142120	983409	142285	972067
20	30	32	142121	983410	142286	972068
20	100	32	142122	983411	142287	972069
20	300	32	142123	983412	142288	972070
25	30	32	142124	983413	142289	972071
25	100	32	142125	983414	142290	972072
25	300	32	142126	983415	142291	972073
32	30	32	142127	983416	142292	972074
32	100	32	142128	983417	142293	972075
32	300	32	142129	983418	142294	972076
40	30	32	142130	983419	142295	972077
40	100	32	142131	983420	142296	972078
40	300	32	142132	983421	142297	972079

1~40A, AC type, Icn=6000A

★ NB1L-40, 4P



In (A)	I Δ n (mA)	CTN	Order Code			
			Curve B		Curve C	
			Standard	RoHS	Standard	RoHS
1	30	24	142133	983422	142298	972080
1	100	24	142134	983423	142299	972081
1	300	24	142135	983424	142300	972082
2	30	24	142136	983425	142301	972083
2	100	24	142137	983426	142302	972084
2	300	24	142138	983427	142303	972085
3	30	24	142139	983428	142304	972086
3	100	24	142140	983429	142305	972087
3	300	24	142141	983430	142306	972088
4	30	24	142142	983431	142307	972089
4	100	24	142143	983432	142308	972090
4	300	24	142144	983433	142309	972091
6	30	24	142145	983434	142310	972092
6	100	24	142146	983435	142311	972093
6	300	24	142147	983436	142312	972094
10	30	24	142148	983437	142313	972095
10	100	24	142149	983438	142314	972096
10	300	24	142150	983439	142315	972097
16	30	24	142151	983440	142316	972098
16	100	24	142152	983441	142317	972099
16	300	24	142153	983442	142318	972100
20	30	24	142154	983443	142319	972101
20	100	24	142155	983444	142320	972102
20	300	24	142156	983445	142321	972103
25	30	24	142157	983446	142322	972104
25	100	24	142158	983447	142323	972105
25	300	24	142159	983448	142324	972106
32	30	24	142160	983449	142325	972107
32	100	24	142161	983450	142326	972108
32	300	24	142162	983451	142327	972109
40	30	24	142163	983452	142328	972110
40	100	24	142164	983453	142329	972111
40	300	24	142165	983454	142330	972112

1~40A, A type, Icn=6000A

★ NB1L-40, 1P+N



In (A)	I Δ n (mA)	CTN	Order Code			
			Curve B		Curve C	
			Standard	RoHS	Standard	RoHS
1	30	80	146001	983455	146166	983620
1	100	80	146002	983456	146167	983621
1	300	80	146003	983457	146168	983622
2	30	80	146004	983458	146169	983623
2	100	80	146005	983459	146170	983624
2	300	80	146006	983460	146171	983625
3	30	80	146007	983461	146172	983626
3	100	80	146008	983462	146173	983627
3	300	80	146009	983463	146174	983628
4	30	80	146010	983464	146175	983629
4	100	80	146011	983465	146176	983630
4	300	80	146012	983466	146177	983631
6	30	80	146013	983467	146178	983632
6	100	80	146014	983468	146179	983633
6	300	80	146015	983469	146180	983634
10	30	80	146016	983470	146181	983635
10	100	80	146017	983471	146182	983636
10	300	80	146018	983472	146183	983637
16	30	80	146019	983473	146184	983638
16	100	80	146020	983474	146185	983639
16	300	80	146021	983475	146186	983640
20	30	80	146022	983476	146187	983641
20	100	80	146023	983477	146188	983642
20	300	80	146024	983478	146189	983643
25	30	80	146025	983479	146190	983644
25	100	80	146026	983480	146191	983645
25	300	80	146027	983481	146192	983646
32	30	80	146028	983482	146193	983647
32	100	80	146029	983483	146194	983648
32	300	80	146030	983484	146195	983649
40	30	80	146031	983485	146196	983650
40	100	80	146032	983486	146197	983651
40	300	80	146033	983487	146198	983652

1~40A, A type, Icn=6000A

★NB1L-40, 2P



In (A)	I Δ n (mA)	CTN	Order Code			
			Curve B		Curve C	
			Standard	RoHS	Standard	RoHS
1	30	42	146034	983488	146199	983653
1	100	42	146035	983489	146200	983654
1	300	42	146036	983490	146201	983655
2	30	42	146037	983491	146202	983656
2	100	42	146038	983492	146203	983657
2	300	42	146039	983493	146204	983658
3	30	42	146040	983494	146205	983659
3	100	42	146041	983495	146206	983660
3	300	42	146042	983496	146207	983661
4	30	42	146043	983497	146208	983662
4	100	42	146044	983498	146209	983663
4	300	42	146045	983499	146210	983664
6	300	42	146046	983500	146211	983665
6	30	42	146047	983501	146212	983666
6	100	42	146048	983502	146213	983667
10	300	42	146049	983503	146214	983668
10	30	42	146050	983504	146215	983669
10	100	42	146051	983505	146216	983670
16	300	42	146052	983506	146217	983671
16	30	42	146053	983507	146218	983672
16	100	42	146054	983508	146219	983673
20	300	42	146055	983509	146220	983674
20	30	42	146056	983510	146221	983675
20	100	42	146057	983511	146222	983676
25	300	42	146058	983512	146223	983677
25	300	42	146059	983513	146224	983678
25	30	42	146060	983514	146225	983679
32	100	42	146061	983515	146226	983680
32	300	42	146062	983516	146227	983681
32	300	42	146063	983517	146228	983682
40	30	42	146064	983518	146229	983683
40	100	42	146065	983519	146230	983684
40	300	42	146066	983520	146231	983685

1~40A, A type, Icn=6000A

★NB1L-40, 3P



In (A)	I Δ n (mA)	CTN	Order Code			
			Curve B		Curve C	
			Standard	RoHS	Standard	RoHS
1	30	32	146067	983521	146232	983686
1	100	32	146068	983522	146233	983687
1	300	32	146069	983523	146234	983688
2	30	32	146070	983524	146235	983689
2	100	32	146071	983525	146236	983690
2	300	32	146072	983526	146237	983691
3	30	32	146073	983527	146238	983692
3	100	32	146074	983528	146239	983693
3	300	32	146075	983529	146240	983694
4	30	32	146076	983530	146241	983695
4	100	32	146077	983531	146242	983696
4	300	32	146078	983532	146243	983697
6	30	32	146079	983533	146244	983698
6	100	32	146080	983534	146245	983699
6	300	32	146081	983535	146246	983700
10	30	32	146082	983536	146247	983701
10	100	32	146083	983537	146248	983702
10	300	32	146084	983538	146249	983703
16	30	32	146085	983539	146250	983704
16	100	32	146086	983540	146251	983705
16	300	32	146087	983541	146252	983706
20	30	32	146088	983542	146253	983707
20	100	32	146089	983543	146254	983708
20	300	32	146090	983544	146255	983709
25	30	32	146091	983545	146256	983710
25	100	32	146092	983546	146257	983711
25	300	32	146093	983547	146258	983712
32	30	32	146094	983548	146259	983713
32	100	32	146095	983549	146260	983714
32	300	32	146096	983550	146261	983715
40	30	32	146097	983551	146262	983716
40	100	32	146098	983552	146263	983717
40	300	32	146099	983553	146264	983718

1~40A, A type, Icn=6000A

★ NB1L-40, 3P+N



In (A)	I Δ n (mA)	CTN	Order Code			
			Curve B		Curve C	
			Standard	RoHS	Standard	RoHS
1	30	32	146100	983554	146265	983719
1	100	32	146101	983555	146266	983720
1	300	32	146102	983556	146267	983721
2	30	32	146103	983557	146268	983722
2	100	32	146104	983558	146269	983723
2	300	32	146105	983559	146270	983724
3	30	32	146106	983560	146271	983725
3	100	32	146107	983561	146272	983726
3	300	32	146108	983562	146273	983727
4	30	32	146109	983563	146274	983728
4	100	32	146110	983564	146275	983729
4	300	32	146111	983565	146276	983730
6	30	32	146112	983566	146277	983731
6	100	32	146113	983567	146278	983732
6	300	32	146114	983568	146279	983733
10	30	32	146115	983569	146280	983734
10	100	32	146116	983570	146281	983735
10	300	32	146117	983571	146282	983736
16	30	32	146118	983572	146283	983737
16	100	32	146119	983573	146284	983738
16	300	32	146120	983574	146285	983739
20	30	32	146121	983575	146286	983740
20	100	32	146122	983576	146287	983741
20	300	32	146123	983577	146288	983742
25	30	32	146124	983578	146289	983743
25	100	32	146125	983579	146290	983744
25	300	32	146126	983580	146291	983745
32	30	32	146127	983581	146292	983746
32	100	32	146128	983582	146293	983747
32	300	32	146129	983583	146294	983748
40	30	32	146130	983584	146295	983749
40	100	32	146131	983585	146296	983750
40	300	32	146132	983586	146297	983751

1~40A, A type, Icn=6000A

★ NB1L-40, 4P



In (A)	I Δ n (mA)	CTN	Order Code			
			Curve B		Curve C	
			Standard	RoHS	Standard	RoHS
1	30	24	146133	983587	146298	983752
1	100	24	146134	983588	146299	983753
1	300	24	146135	983589	146300	983754
2	30	24	146136	983590	146301	983755
2	100	24	146137	983591	146302	983756
2	300	24	146138	983592	146303	983757
3	30	24	146139	983593	146304	983758
3	100	24	146140	983594	146305	983759
3	300	24	146141	983595	146306	983760
4	30	24	146142	983596	146307	983761
4	100	24	146143	983597	146308	983762
4	300	24	146144	983598	146309	983763
6	30	24	146145	983599	146310	983764
6	100	24	146146	983600	146311	983765
6	300	24	146147	983601	146312	983766
10	30	24	146148	983602	146313	983767
10	100	24	146149	983603	146314	983768
10	300	24	146150	983604	146315	983769
16	30	24	146151	983605	146316	983770
16	100	24	146152	983606	146317	983771
16	300	24	146153	983607	146318	983772
20	30	24	146154	983608	146319	983773
20	100	24	146155	983609	146320	983774
20	300	24	146156	983610	146321	983775
25	30	24	146157	983611	146322	983776
25	100	24	146158	983612	146323	983777
25	300	24	146159	983613	146324	983778
32	30	24	146160	983614	146325	983779
32	100	24	146161	983615	146326	983780
32	300	24	146162	983616	146327	983781
40	30	24	146163	983617	146328	983782
40	100	24	146164	983618	146329	983783
40	300	24	146165	983619	146330	983784

1~40A, A type, Icn=10000A

★ NB1L-40H, 1P+N



In (A)	I _{Δn} (mA)	CTN	Order Code			
			Curve B		Curve C	
			Standard	RoHS	Standard	RoHS
1	30	80	146501	982479	146681	982674
1	100	80	146502	982480	146682	982675
1	300	80	146503	982481	146683	982676
2	30	80	146504	982482	146684	982677
2	100	80	146505	982483	146685	982678
2	300	80	146506	982484	146686	982679
3	30	80	146507	982485	146687	982680
3	100	80	146508	982486	146688	982681
3	300	80	146509	982487	146689	982682
4	30	80	146510	982488	146690	982683
4	100	80	146511	982489	146691	982684
4	300	80	146512	982490	146692	982685
6	30	80	146513	982491	146693	982686
6	100	80	146514	982492	146694	982687
6	300	80	146515	982493	146695	982688
8	30	80	190001	982494	190016	982689
8	100	80	190002	982495	190017	982690
8	300	80	190003	982496	190018	982691
10	30	80	146516	982497	146696	982692
10	100	80	146517	982498	146697	982693
10	300	80	146518	982499	146698	982694
13	30	80	146519	982500	146699	982695
13	100	80	146520	982501	146700	982696
13	300	80	146521	982502	146701	982697
16	30	80	146522	982503	146702	982698
16	100	80	146523	982504	146703	982699
16	300	80	146524	982505	146704	982700
20	30	80	146525	982506	146705	982701
20	100	80	146526	982507	146706	982702
20	300	80	146527	982508	146707	982703
25	30	80	146528	982509	146708	982704
25	100	80	146529	982510	146709	982705
25	300	80	146530	982511	146710	982706
32	30	80	146531	982512	146711	982707
32	100	80	146532	982513	146712	982708
32	300	80	146533	982514	146713	982709
40	30	80	146534	982515	146714	982710
40	100	80	146535	982516	146715	982711
40	300	80	146536	982517	146716	982712

1~40A, A type, Icn=10000A

★ NB1L-40H, 2P



In (A)	I _{Δn} (mA)	CTN	Order Code			
			Curve B		Curve C	
			Standard	RoHS	Standard	RoHS
1	30	42	146537	982518	146717	982713
1	100	42	146538	982519	146718	982714
1	300	42	146539	982520	146719	982715
2	30	42	146540	982521	146720	982716
2	100	42	146541	982522	146721	982717
2	300	42	146542	982523	146722	982718
3	30	42	146543	982524	146723	982719
3	100	42	146544	982525	146724	982720
3	300	42	146545	982526	146725	982721
4	30	42	146546	982527	146726	982722
4	100	42	146547	982528	146727	982723
4	300	42	146548	982529	146728	982724
6	30	42	146549	982530	146729	982725
6	100	42	146550	982531	146730	982726
6	300	42	146551	982532	146731	982727
8	30	42	190004	982533	190019	982728
8	100	42	190005	982534	190020	982729
8	300	42	190006	982535	190021	982730
10	30	42	146552	982536	146732	982731
10	100	42	146553	982537	146733	982732
10	300	42	146554	982538	146734	982733
13	30	42	146555	982539	146735	982734
13	100	42	146556	982540	146736	982735
13	300	42	146557	982541	146737	982736
16	30	42	146558	982542	146738	982737
16	100	42	146559	982543	146739	982738
16	300	42	146560	982544	146740	982739
20	30	42	146561	982545	146741	982740
20	100	42	146562	982546	146742	982741
20	300	42	146563	982547	146743	982742
25	30	42	146564	982548	146744	982743
25	100	42	146565	982549	146745	982744
25	300	42	146566	982550	146746	982745
32	30	42	146567	982551	146747	982746
32	100	42	146568	982552	146748	982747
32	300	42	146569	982553	146749	982748
40	30	42	146570	982554	146750	982749
40	100	42	146571	982555	146751	982750
40	300	42	146572	982556	146752	982751

1~40A, A type, Icn=10000A

★ NB1L-40H, 3P



In (A)	I _{Δn} (mA)	CTN	Order Code			
			Curve B		Curve C	
			Standard	RoHS	Standard	RoHS
1	30	32	146573	982557	146753	982752
1	100	32	146574	982558	146754	982753
1	300	32	146575	982559	146755	982754
2	30	32	146576	982560	146756	982755
2	100	32	146577	982561	146757	982756
2	300	32	146578	982562	146758	982757
3	30	32	146579	982563	146759	982758
3	100	32	146580	982564	146760	982759
3	300	32	146581	982565	146761	982760
4	30	32	146582	982566	146762	982761
4	100	32	146583	982567	146763	982762
4	300	32	146584	982568	146764	982763
6	30	32	146585	982569	146765	982764
6	100	32	146586	982570	146766	982765
6	300	32	146587	982571	146767	982766
8	30	32	146588	982572	146768	982767
8	100	32	146589	982573	146769	982768
8	300	32	146590	982574	146770	982769
10	30	32	146591	982575	146771	982770
10	100	32	146592	982576	146772	982771
10	300	32	146593	982577	146773	982772
13	30	32	146594	982578	146774	982773
13	100	32	146595	982579	146775	982774
13	300	32	146596	982580	146776	982775
16	30	32	146597	982581	146777	982776
16	100	32	146598	982582	146778	982777
16	300	32	146599	982583	146779	982778
20	30	32	146600	982584	146780	982779
20	100	32	146601	982585	146781	982780
20	300	32	146602	982586	146782	982781
25	30	32	146603	982587	146783	982782
25	100	32	146604	982588	146784	982783
25	300	32	146605	982589	146785	982784
32	30	32	146606	982590	146786	982785
32	100	32	146607	982591	146787	982786
32	300	32	146608	982592	146788	982787
40	30	32	146609	982593	146789	982788
40	100	32	146610	982594	146790	982789
40	300	32	146611	982595	146791	982780

1~40A, A type, Icn=10000A

★ NB1L-40H, 3P+N



In (A)	I _{Δn} (mA)	CTN	Order Code			
			Curve B		Curve C	
			Standard	RoHS	Standard	RoHS
1	30	32	146609	982596	146789	982791
1	100	32	146610	982597	146790	982792
1	300	32	146611	982598	146791	982793
2	30	32	146612	982599	146792	982794
2	100	32	146613	982600	146793	982795
2	300	32	146614	982601	146794	982796
3	30	32	146615	982602	146795	982797
3	100	32	146616	982603	146796	982798
3	300	32	146617	982604	146797	982799
4	30	32	146618	982605	146798	982800
4	100	32	146619	982606	146799	982801
4	300	32	146620	982607	146800	982802
6	30	32	146621	982608	146801	982803
6	100	32	146622	982609	146802	982804
6	300	32	146623	982610	146803	982805
8	30	32	190010	982611	190025	982806
8	100	32	190011	982612	190026	982807
8	300	32	190012	982613	190027	982808
10	30	32	146624	982614	146804	982809
10	100	32	146625	982615	146805	982810
10	300	32	146626	982616	146806	982811
13	30	32	146627	982617	146807	982812
13	100	32	146628	982618	146808	982813
13	300	32	146629	982619	146809	982814
16	30	32	146630	982620	146810	982815
16	100	32	146631	982621	146811	982816
16	300	32	146632	982622	146812	982817
20	30	32	146633	982623	146813	982818
20	100	32	146634	982624	146814	982819
20	300	32	146635	982625	146815	982820
25	30	32	146636	982626	146816	982821
25	100	32	146637	982627	146817	982822
25	300	32	146638	982628	146818	982823
32	30	32	146639	982629	146819	982824
32	100	32	146640	982630	146820	982825
32	300	32	146641	982631	146821	982826
40	30	32	146642	982632	146822	982827
40	100	32	146643	982633	146823	982828
40	300	32	146644	982634	146824	982829

1~40A, A type, Icn=10000A

★ NB1L-40H, 4P



In (A)	I Δ n (mA)	CTN	Order Code			
			Curve B		Curve C	
			Standard	RoHS	Standard	RoHS
1	30	24	146645	982635	146825	982830
1	100	24	146646	982636	146826	982831
1	300	24	146647	982637	146827	982832
2	30	24	146648	982638	146828	982833
2	100	24	146649	982639	146829	982834
2	300	24	146650	982640	146830	982835
3	30	24	146651	982641	146831	982836
3	100	24	146652	982642	146832	982837
3	300	24	146653	982643	146833	982838
4	30	24	146654	982644	146834	982839
4	100	24	146655	982645	146835	982840
4	300	24	146656	982646	146836	982841
6	30	24	146657	982647	146837	982842
6	100	24	146658	982648	146838	982843
6	300	24	146659	982649	146839	982844
8	30	24	190013	982650	190028	982845
8	100	24	190014	982651	190029	982846
8	300	24	190015	982652	190030	982847
10	30	32	146660	982653	146840	982848
10	100	24	146661	982654	146841	982849
10	300	24	146662	982655	146842	982850
13	30	24	146663	982656	146843	982851
13	100	24	146664	982657	146844	982852
13	300	24	146665	982658	146845	982853
16	30	24	146666	982659	146846	982854
16	100	24	146667	982660	146847	982855
16	300	24	146668	982661	146848	982856
20	30	24	146669	982662	146849	982857
20	100	24	146670	982663	146850	982858
20	300	24	146671	982664	146851	982859
25	30	24	146672	982665	146852	982860
25	100	24	146673	982666	146853	982861
25	300	24	146674	982667	146854	982862
32	30	24	146675	982668	146855	982863
32	100	24	146676	982669	146856	982864
32	300	24	146677	982670	146857	982865
40	30	24	146678	982671	146858	982866
40	100	24	146679	982672	146859	982867
40	300	24	146680	982673	146860	982868

1~40A, AC type, Icn=10000A

★ NB1L-40H, 1P+N



In (A)	I Δ n (mA)	CTN	Order Code			
			Curve B		Curve C	
			Standard	RoHS	Standard	RoHS
1	30	80	146861	982869	147041	983064
1	100	80	146862	982870	147042	983065
1	300	80	146863	982871	147043	983066
2	30	80	146864	982872	147044	983067
2	100	80	146865	982873	147045	983068
2	300	80	146866	982874	147046	983069
3	30	80	146867	982875	147047	983070
3	100	80	146868	982876	147048	983071
3	300	80	146869	982877	147049	983072
4	30	80	146870	982878	147050	983073
4	100	80	146871	982879	147051	983074
4	300	80	146872	982880	147052	983075
6	30	80	146873	982881	147053	983076
6	100	80	146874	982882	147054	983077
6	300	80	146875	982883	147055	983078
8	30	80	190032	982884	190047	983079
8	100	80	190033	982885	190048	983080
8	300	80	190034	982886	190049	983081
10	30	80	146876	982887	147056	983082
10	100	80	146877	982888	147057	983083
10	300	80	146878	982889	147058	983084
13	30	80	146879	982890	147059	983085
13	100	80	146880	982891	147060	983086
13	300	80	146881	982892	147061	983087
16	30	80	146882	982893	147062	983088
16	100	80	146883	982894	147063	983089
16	300	80	146884	982895	147064	983090
20	30	80	146885	982896	147065	983091
20	100	80	146886	982897	147066	983092
20	300	80	146887	982898	147067	983093
25	30	80	146888	982899	147068	983094
25	100	80	146889	982900	147069	983095
25	300	80	146890	982901	147070	983096
32	30	80	146891	982902	147071	983097
32	100	80	146892	982903	147072	983098
32	300	80	146893	982904	147073	983099
40	30	80	146894	982905	147074	983100
40	100	80	146895	982906	147075	983101
40	300	80	146896	982907	147076	983102

1~40A, AC type, Icn=10000A

★ NB1L-40H, 2P



1~40A, AC type, Icn=10000A

★ NB1L-40H, 3P



In (A)	I _{Δn} (mA)	CTN	Order Code			
			Curve B		Curve C	
			Standard	RoHS	Standard	RoHS
1	30	42	146897	982908	147077	983103
1	100	42	146898	982909	147078	983104
1	300	42	146899	982910	147079	983105
2	30	42	146900	982911	147080	983106
2	100	42	146901	982912	147081	983107
2	300	42	146902	982913	147082	983108
3	30	42	146903	982914	147083	983109
3	100	42	146904	982915	147084	983110
3	300	42	146905	982916	147085	983111
4	30	42	146906	982917	147086	983112
4	100	42	146907	982918	147087	983113
4	300	42	146908	982919	147088	983114
6	30	42	146909	982920	147089	983115
6	100	42	146910	982921	147090	983116
6	300	42	146911	982922	147091	983117
8	30	42	190035	982923	190050	983118
8	100	42	190036	982924	190051	983119
8	300	42	190037	982925	190052	983120
10	30	42	146912	982926	147092	983121
10	100	42	146913	982927	147093	983122
10	300	42	146914	982928	147094	983123
13	30	42	146915	982929	147095	983124
13	100	42	146916	982930	147096	983125
13	300	42	146917	982931	147097	983126
16	30	42	146918	982932	147098	983127
16	100	42	146919	982933	147099	983128
16	300	42	146920	982934	147100	983129
20	30	42	146921	982935	147101	983130
20	100	42	146922	982936	147102	983131
20	300	42	146923	982937	147103	983132
25	30	42	146924	982938	147104	983133
25	100	42	146925	982939	147105	983134
25	300	42	146926	982940	147106	983135
32	30	42	146927	982941	147107	983136
32	100	42	146928	982942	147108	983137
32	300	42	146929	982943	147109	983138
40	30	42	146930	982944	147110	983139
40	100	42	146931	982945	147111	983140
40	300	42	146932	982946	147112	983141

In (A)	I _{Δn} (mA)	CTN	Order Code			
			Curve B		Curve C	
			Standard	RoHS	Standard	RoHS
1	30	32	146933	982947	147113	983142
1	100	32	146934	982948	147114	983143
1	300	32	146935	982949	147115	983144
2	30	32	146936	982950	147116	983145
2	100	32	146937	982951	147117	983146
2	300	32	146938	982952	147118	983147
3	30	32	146939	982953	147119	983148
3	100	32	146940	982954	147120	983149
3	300	32	146941	982955	147121	983150
4	30	32	146942	982956	147122	983151
4	100	32	146943	982957	147123	983152
4	300	32	146944	982958	147124	983153
6	30	32	146945	982959	147125	983154
6	100	32	146946	982960	147126	983155
6	300	32	146947	982961	147127	983156
8	30	32	190038	982962	190053	983157
8	100	32	190039	982963	190054	983158
8	300	32	190040	982964	190055	983159
10	30	32	146948	982965	147128	983160
10	100	32	146949	982966	147129	983161
10	300	32	146950	982967	147130	983162
13	30	32	146951	982968	147131	983163
13	100	32	146952	982969	147132	983164
13	300	32	146953	982970	147133	983165
16	30	32	146954	982971	147134	983166
16	100	32	146955	982972	147135	983167
16	300	32	146956	982973	147136	983168
20	30	32	146957	982974	147137	983169
20	100	32	146958	982975	147138	983170
20	300	32	146959	982976	147139	983171
25	30	32	146960	982977	147140	983172
25	100	32	146961	982978	147141	983173
25	300	32	146962	982979	147142	983174
32	30	32	146963	982980	147143	983175
32	100	32	146964	982981	147144	983176
32	300	32	146965	982982	147145	983177
40	30	32	146966	982983	147146	983178
40	100	32	146967	982984	147147	983179
40	300	32	146968	982985	147148	983180

1~40A, AC type, Icn=10000A

★ NB1L-40H, 3P+N



In (A)	I Δ n (mA)	CTN	Order Code			
			Curve B		Curve C	
			Standard	RoHS	Standard	RoHS
1	30	32	146969	982986	147149	983181
1	100	32	146970	982987	147150	983182
1	300	32	146971	982988	147151	983183
2	30	32	146972	982989	147152	983184
2	100	32	146973	982990	147153	983185
2	300	32	146974	982991	147154	983186
3	30	32	146975	982992	147155	983187
3	100	32	146976	982993	147156	983188
3	300	32	146977	982994	147157	983189
4	30	32	146978	982995	147158	983190
4	100	32	146979	982996	147159	983191
4	300	32	146980	982997	147160	983192
6	30	32	146981	982998	147161	983193
6	100	32	146982	982999	147162	983194
6	300	32	146983	983000	147163	983195
8	30	32	190041	983001	190056	983196
8	100	32	190042	983002	190057	983197
8	300	32	190043	983003	190058	983198
10	30	32	146984	983004	147164	983199
10	100	32	146985	983005	147165	983200
10	300	32	146986	983006	147166	983201
13	30	32	146987	983007	147167	983202
13	100	32	146988	983008	147168	983203
13	300	32	146989	983009	147169	983204
16	30	32	146990	983010	147170	983205
16	100	32	146991	983011	147171	983206
16	300	32	146992	983012	147172	983207
20	30	32	146993	983013	147173	983208
20	100	32	146994	983014	147174	983209
20	300	32	146995	983015	147175	983210
25	30	32	146996	983016	147176	983211
25	100	32	146997	983017	147177	983212
25	300	32	146998	983018	147178	983213
32	30	32	146999	983019	147179	983214
32	100	32	147000	983020	147180	983215
32	300	32	147001	983021	147181	983216
40	30	32	147002	983022	147182	983217
40	100	32	147003	983023	147183	983218
40	300	32	147004	983024	147184	983219

1~40A, AC type, Icn=10000A

★ NB1L-40H, 4P



In (A)	I Δ n (mA)	CTN	Order Code			
			Curve B		Curve C	
			Standard	RoHS	Standard	RoHS
1	30	24	147005	983025	147185	983220
1	100	24	147006	983026	147186	983221
1	300	24	147007	983027	147187	983222
2	30	24	147008	983028	147188	983223
2	100	24	147009	983029	147189	983224
2	300	24	147010	983030	147190	983225
3	30	24	147011	983031	147191	983226
3	100	24	147012	983032	147192	983227
3	300	24	147013	983033	147193	983228
4	30	24	147014	983034	147194	983229
4	100	24	147015	983035	147195	983230
4	300	24	147016	983036	147196	983231
6	30	24	147017	983037	147197	983232
6	100	24	147018	983038	147198	983233
6	300	24	147019	983039	147199	983234
8	30	24	190044	983040	190059	983235
8	100	24	190045	983041	190060	983236
8	300	24	190046	983042	190061	983237
10	30	24	147020	983043	147200	983238
10	100	24	147021	983044	147201	983239
10	300	24	147022	983045	147202	983240
13	30	24	147023	983046	147203	983241
13	100	24	147024	983047	147204	983242
13	300	24	147025	983048	147205	983243
16	30	24	147026	983049	147206	983244
16	100	24	147027	983050	147207	983245
16	300	24	147028	983051	147208	983246
20	30	24	147029	983052	147209	983247
20	100	24	147030	983053	147210	983248
20	300	24	147031	983054	147211	983249
25	30	24	147032	983055	147212	983250
25	100	24	147033	983056	147213	983251
25	300	24	147034	983057	147214	983252
32	30	24	147035	983058	147215	983253
32	100	24	147036	983059	147216	983254
32	300	24	147037	983060	147217	983255
40	30	24	147038	983061	147218	983256
40	100	24	147039	983062	147219	983257
40	300	24	147040	983063	147220	983258

50~63A, AC type, Icn=6000A

★ NB1L-63, 1P+N



In (A)	I Δ n (mA)	CTN	Order Code	
			Curve C	
			Standard	RoHS
50	30	64	142531	972113
50	100	64	142532	972114
50	300	64	142533	972115
63	30	64	142534	972116
63	100	64	142535	972117
63	300	64	142536	972118

50~63A, AC type, Icn=6000A

★ NB1L-63, 2P



In (A)	I Δ n (mA)	CTN	Order Code	
			Curve C	
			Standard	RoHS
50	30	52	142537	972119
50	100	52	142538	972120
50	300	52	142539	972121
63	30	52	142540	972122
63	100	52	142541	972123
63	300	52	142542	972124

50~63A, AC type, Icn=6000A

★ NB1L-63, 3P



In (A)	I Δ n (mA)	CTN	Order Code	
			Curve C	
			Standard	RoHS
50	30	32	142543	972125
50	100	32	142544	972126
50	300	32	142545	972127
63	30	32	142546	972128
63	100	32	142547	972129
63	300	32	142548	972130

50~63A, AC type, Icn=6000A

★ NB1L-63, 3P+N



In (A)	I Δ n (mA)	CTN	Order Code	
			Curve C	
			Standard	RoHS
50	30	32	142549	972131
50	100	32	142550	972132
50	300	32	142551	972133
63	30	32	142552	972134
63	100	32	142553	972135
63	300	32	142554	972136

50~63A, AC type, Icn=6000A

★ NB1L, 4P



In (A)	I Δ n (mA)	CTN	Order Code	
			Curve C	
			Standard	RoHS
50	30	18	142555	972137
50	100	18	142556	972138
50	300	18	142557	972139
63	30	18	142558	972140
63	100	18	142559	972141
63	300	18	142560	972142

3. Technical data

3.1 Curves

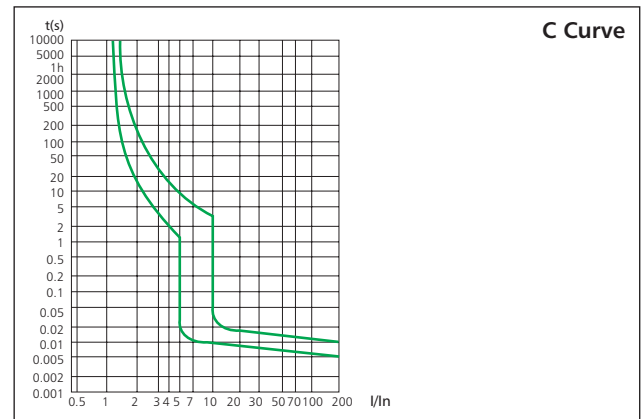
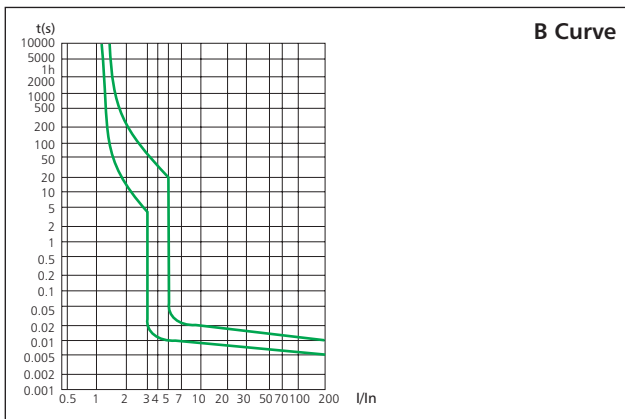

3.2

	Standard		IEC/EN 61009-1		
Electrical features	Type (wave form of the earth leakage sensed)		AC, A		
	Thermo-magnetic release characteristic		B, C		
	Rated current I_n	A	MCB+add-on RCCB block	1, 2, 3, 4, 6, 8, 10, 13, 16, 20, 25, 32, 40	50, 63
			Combined	1-25/6-40	
	Poles		MCB+add-on RCCB block	1P+N, 2P	
			Combined	1P+N, 2P, 3P, 3P+N, 4P	
	Rated voltage U_e	V	230/400~240/415		
	Rated sensitivity $I_{\Delta n}$	A	0.03, 0.1, 0.3		
	Rated residual making and breaking capacity $I_{\Delta m}$	A	500 ($I_n \leq 40A$)		
			630 ($I_n > 40A$)		
	Rated short-circuit capacity I_{cn}	A	6,000/10,000		
	Break time under $I_{\Delta n}$	s	≤ 0.1		
	Rated frequency	Hz	50/60		
	Rated impulse withstand voltage (1.2/50) U_{imp}	V	6,000		
Dielectric TEST voltage at ind. Freq. for 1 min	kV	2			
Insulation voltage U_i		500			
Pollution degree		2			
Mechanical features	Electrical life		2,000		
	Mechanical life		2,000		
	Contact position indicator		Yes		
	Protection degree		IP20		
	Ambient temperature (with daily average $\leq 35^\circ C$)	$^\circ C$	-5...+40 (Special application please refer to P55 for temperature compensation correction)		
	Storage temperature	$^\circ C$	-25...+70		
Installation	Terminal connection type		Cable/U-type busbar/Pin-type busbar		
	Terminal size top/bottom for cable	mm^2	25		
		AWG	18-3		
	Terminal size top/bottom for busbar	mm^2	10		
		AWG	18-8		
	Tightening torque	N*m	2		
		In-lbs.	18		
Mounting		On DIN rail EN 60715 (35mm) by means of fast clip device			
Connection		From top and bottom (for combined type)			
		From top (MCB+add-on RCCB block)			

3.3 Temperature derating

The maximum permissible current in a circuit breaker depends on the ambient temperature where the circuit breaker is placed. Ambient temperature is the temperature inside the enclosure or switchboard in which the circuit breakers are installed. **The reference temperature is 30°C**

Temperature	-10°C	0°C	10°C	20°C	30°C	40°C	50°C	60°C
Temperature compensation coefficient of rated current	1.20	1.15	1.10	1.05	1.00	0.95	0.90	0.85

4. Overall and mounting dimensions (mm)

4.1 MCB+add-on RCCB block

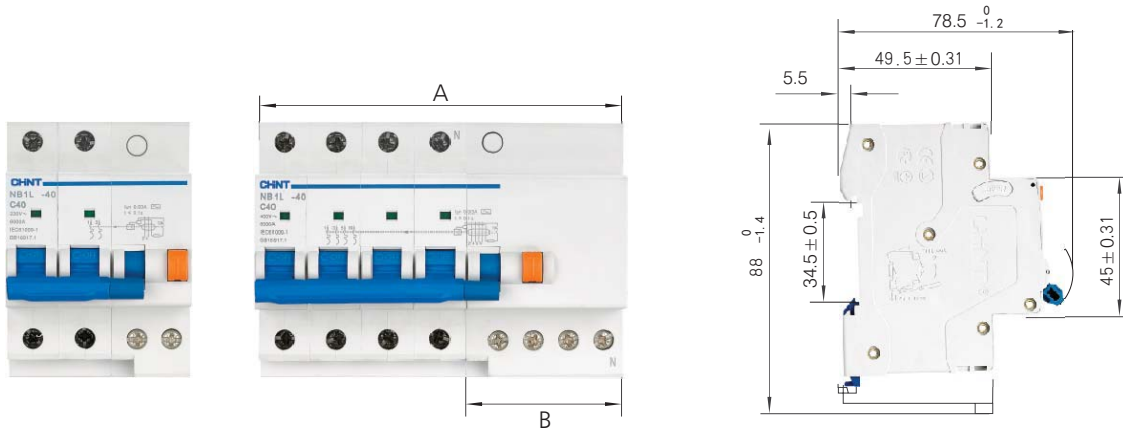

Number of poles	Overall dimensions A (mm)	
	1~40A	50~63A
1P+N	45 ⁰ _{-0.62}	54 ⁰ _{-0.74}
2P	63 ⁰ _{-0.74}	72 ⁰ _{-0.74}
3P	108 ⁰ _{-1.4}	117 ⁰ _{-1.4}
3P+N	108 ⁰ _{-1.4}	117 ⁰ _{-1.4}
4P	126 ⁰ _{-1.6}	135 ⁰ _{-1.6}
	B(mm)	
1P+N	27 ⁰ _{-0.52}	36 ⁰ _{-0.62}
2P	27 ⁰ _{-0.52}	36 ⁰ _{-0.62}
3P	54 ⁰ _{-1.20}	63 ⁰ _{-1.2}
3P+N	54 ⁰ _{-1.20}	63 ⁰ _{-1.2}
4P	54 ⁰ _{-1.20}	63 ⁰ _{-1.2}

Combined

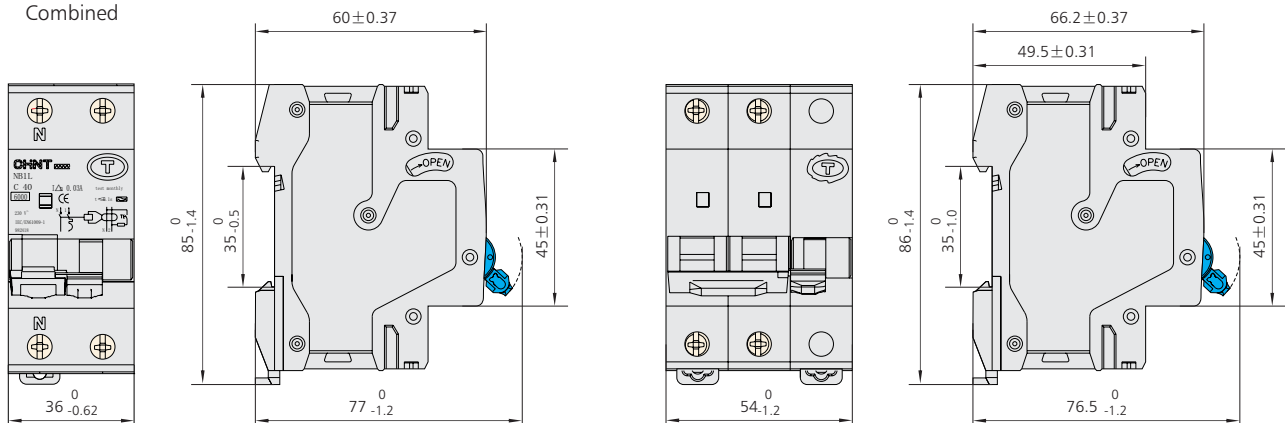



NB7LE Residual Current Operated Circuit Breaker

1. General

The NB7LE residual current operated circuit breaker is applicable to the circuit with an alternating current of 50Hz, rated-voltage single pole and two lines/two poles 230V, three poles/three poles and four lines/four poles 400V, and a rated current up to 63A; when the human body gets an electric shock or the network leak current exceeds the specified value, the residual current operated circuit breaker can rapidly cut off the power supply in trouble within a very short time for the safety of the human body and the powered equipment. With the function of overload and short circuit protection, the residual current operated circuit breaker can be used to protect the circuit or motor from being damaged by overload and short circuit, and can also be used for not-frequent operational transformation in the circuit under normal condition.

The product meets the standards of IEC 61009-1.

2. Type designation

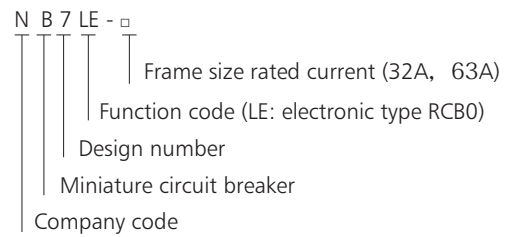

3. Technical data

3.1 Main specifications

3.1.1 Graded as follows according to the rated current In:

NB7LE-32: 6A, 10A, 16A, 20A, 25A, 32A;

NB7LE-63: 6A, 10A, 16A, 20A, 25A, 32A, 40A, 50A, 63A

3.1.2 Classified as follows according to the type of

instantaneous release: C type (5-10) In, D type (10-16) In;

3.1.3 Categorized as follows according to the number of poles and current circuit: Single pole and two lines (1P+N), two poles (2P), three poles(3P), three poles and four lines (3P+N), four poles (4P) for the NB7LE-32;

Single pole and two lines (1P+N), two poles (2P) for the NB7LE-63;

3.1.4 Graded as follows according to the rated residual operating current: 0.03A, 0.1A, 0.3A;

3.2 Technical parameters

3.2.1 Rated short circuit breaking capacity (see Table 1)

3.2.2 Rated residual making and breaking capacity: 2,000A;

3.2.3 Rated residual non-operating current: 0.5I_{Δn};

3.2.4 Breaking time of the residual current operating (see Table 2)

3.2.5 Mechanical/Electrical Life

a. Electrical life: no less than 2,000 times

b. Mechanical life: no less than 2,000 times

3.2.6 Insulation shock-resistance voltage performance

a. The impulse voltage with a peak value of 6,000V can be withstood between the various poles connected together and the neutral pole;

b. The impulse voltage with a peak value of 8,000V can be withstood between the various poles connected with the neutral pole and the metal support;

3.2.7 The residual current operated circuit breaker has the capability of withstanding the impact of the surge current with a peak current of 200A (0.5 μs/100kHz) and 3,000A (8/20 μs) without causing misoperation;

Table 1 Rated short circuit capacity

Rated current In (A)	Number of poles	Rated voltage Ue (V)	Rated short circuit capacity Icn (A)
C type: 6~40	1P+N,2P	230	6000
C type: 6~40	3P, 3P+N, 4P	400	
C type: 50 63	1P+N,2P	230	4500
D type: 6~63	1P+N,2P	230	
D type: 6~32	3P, 3P+N, 4P	400	

Table 2 Maximum breaking time of the residual current operating

In A	IΔn A	Breaking time when the residual current assumes the following values (s)				
		IΔn	2 IΔn	5 IΔn	5A,10A,20A,50A,100A,200A,500A ^a	IΔt ^b
6~63A	0.03,0.1,0.3	0.1	0.05	0.04	0.04	0.04

a. The test of 5A,10A,20A,50A,100A,200A,500A is only performed for the verification of operation, and is not performed for the magnitude of current greater than the lower limit of the over-current instantaneous tripping range.
b. The test is carried out for the current with the IΔn being equal to the lower limit of the over-current instantaneous tripping range for type C or D.

3.2.8 Over current protection characteristic (see Table 3)

Test	Type	Test current	Initial state	Time limit for tripping or not tripping	Expected result	Test environment temperature	Remarks
a	C, D	1.13In	Cold state	$t \geq 1h$	No tripping	30°C~35°C	The current is rising within 5s
b	C, D	1.45In	Right after test a	$t < 1h$	Tripping		
c	C, D	2.55In	Cold state	1s<t<60s (In≤32A) 1s<t<120s (In>32A)	Tripping		
d	C	5In	Cold state	$t \geq 0.1s$	No tripping		The power supply is turned on by closing the auxiliary switch
	D	10In					
e	C	10In	Cold state	$t < 0.1s$	Tripping	The power supply is turned on by closing the auxiliary switch	
	D	16In					

Note: The terminology “Cold state” means that the test is performed at the base calibration temperature with no load prior to the test.

3.2.9 For the tripping performance diagram, see Fig 1

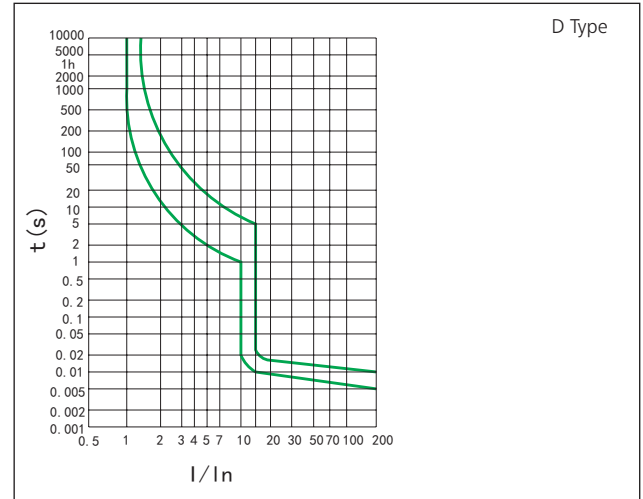
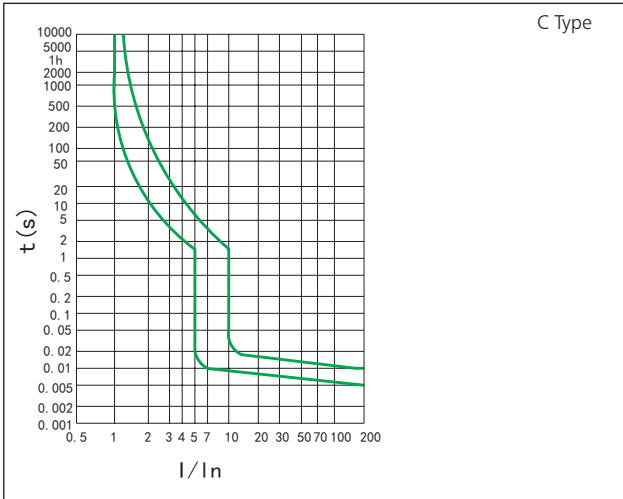

3.2.10 Wiring: suitable for the connection of leads of less than 25mm^2 (see Table 4); wiring method: screw hold-down with a torque of:
 Not less than $0.8\text{N}\cdot\text{m}$ and not greater than $1.2\text{N}\cdot\text{m}$ for the M4 screw
 Not less than $1.5\text{N}\cdot\text{m}$ and not greater than $2.0\text{N}\cdot\text{m}$ for the M5 screw

Table 4 Nominal cross-sectional area of the copper conductor

Rated current I_n (A)	Nominal cross-sectional area of the copper conductor (mm^2)
6	1
10	1.5
16, 20	2.5
25	4
32	6
40, 50	10
63	16

4. Overall and mounting dimensions (mm)

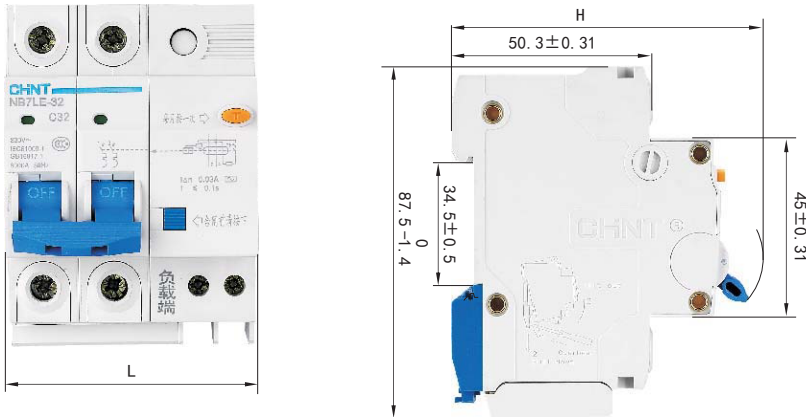

Poles	H (mm)	L (mm)	
		NB7LE-32	NB7LE-63
1P+N	78 ⁰ _{-1.2}	45 ⁰ _{-0.74}	54 ⁰ _{-0.74}
2P	80 ⁰ _{-1.2}	63 ⁰ _{-0.74}	72 ⁰ _{-0.74}
3P	80 ⁰ _{-1.2}	90 ⁰ _{-1.4}	-
3P+N	80 ⁰ _{-1.2}	99 ⁰ _{-1.4}	-
4P	80 ⁰ _{-1.2}	117 ⁰ _{-1.6}	-

5. Ordering information

5.1 When ordering the goods, the user shall indicate the following items:

- 5.1.1 Types and names of products, for example, NB7LE series residual current operated circuit breaker
- 5.1.2 Instantaneous tripping type and rated current, for example, C25;
- 5.1.3 Number of poles: for example, 2P;
- 5.1.4 Rated residual operating current: for example, 0.03A;
- 5.1.5 Quantity on order, for example, 50 units;

5.2 Example for ordering: NB7LE-32 residual current operated circuit breaker, 2P, 0.03A, C25, 50 units.



NB3LE Residual Current Operated Circuit Breaker with Over-current Protection (Electronic)

1. General

1.1 Selection

Rated residual operating current

$I_{\Delta n} = 30 \text{ mA}$: additional protection in the case of direct contact.

Tripping class

AC class – Tripping is ensured for sinusoidal, alternating currents, whether they be quickly applied or slowly increase.

Tripping curve

B curve (3-5 I_n) protection and control of the circuits against overloads and short-circuits; protection for people and big length cables in TN and IT systems.

C curve (5-10 I_n) protection and control of the circuits against overloads and short-circuits; protection for resistive and inductive loads with low inrush current.

1.2 Approvals and certificates

Detailed information, please refer to Certificates Table on the last page.

2. Ordering Information

NB3LE Curve B; 6KA; AC Type

★ NB3LE, 1P+N



In (A)	Un (V)	I Δ n (mA)	Code
6	240	30	984636
10	240	30	984637
13	240	30	984638
16	240	30	984639
20	240	30	984640
25	240	30	984641
32	240	30	984642

NB3LE Curve C; 6KA; AC Type

★ NB3LE, 1P+N



In (A)	Un (V)	I Δ n (mA)	Code
6	240	30	984643
10	240	30	984644
13	240	30	984645
16	240	30	984646
20	240	30	984647
25	240	30	984648
32	240	30	984649

3. Technical data

3.1 Curves

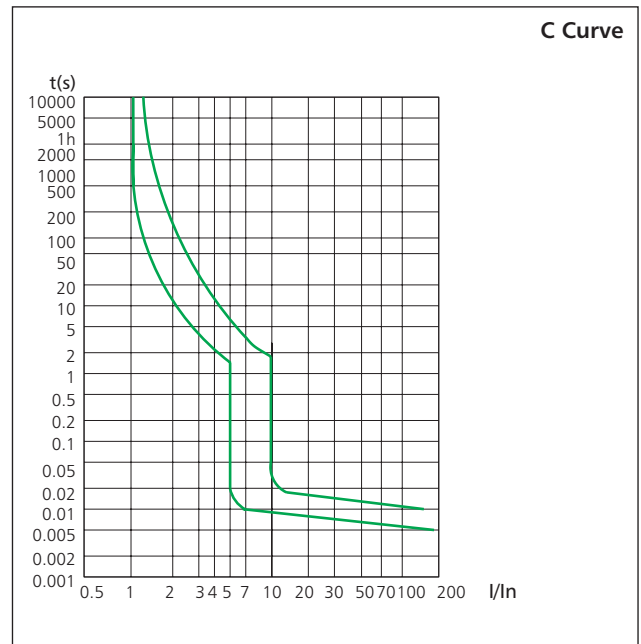
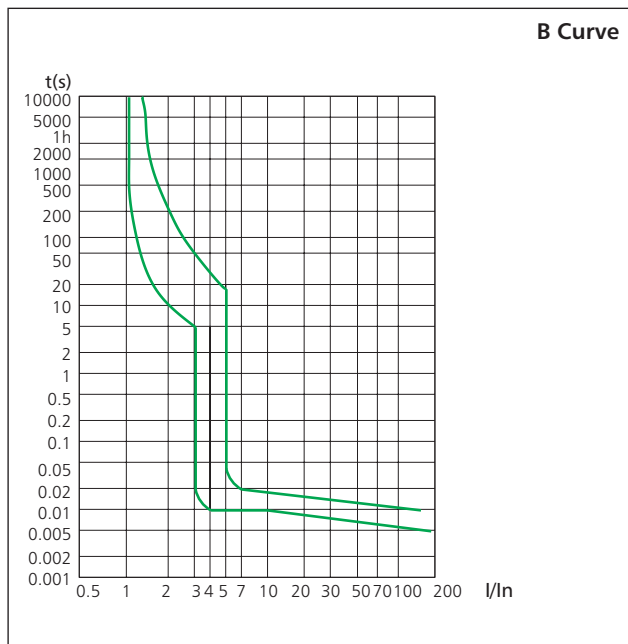

3.2

	Standard		IEC/EN 61009-1
Electrical features	Type (wave form of the earth leakage sensed)		AC
	Thermo-magnetic release characteristic		B, C
	Rated current I _n	A	6, 10, 16, 20, 25, 32
	Poles		1P+N
	Rated voltage U _e	V	240
	Rated sensitivity I _{Δn}	A	0.03
	Rated residual making and breaking capacity I _{Δm}	A	500
	Rated short-circuit capacity I _{cn}	A	6,000
	Break time under I _{Δn}	s	≤0.1
	Rated frequency	Hz	50/60
	Rated impulse withstand voltage (1.2/50)U _{imp}	V	4,000
	Dielectric TEST voltage at ind. Freq. for 1min	kV	2
	Insulation voltage U _i		500
	Pollution degree		2
	Mechanical features	Electrical life	
Mechanical life			2,000
Contact position indicator			Yes
Protection degree			IP20
Ambient temperature (with daily average ≤35 °C)		°C	-5...+40 (Special application please refer to P58 for temperature compensation correction)
Storage temperature		°C	-25...+70
Installation	Terminal connection type		Cable/U-type busbar/Pin-type busbar
	Terminal size top/bottom for cable	mm ²	16
		AWG	18-5
	Terminal size top/bottom for busbar	mm ²	10
		AWG	18-8
	Tightening torque	N*m	2
		In-lbs.	18
	Mounting		On DIN rail EN 60715 (35mm) by means of fast clip device
Connection		From top	

3.3 Temperature derating

The maximum permissible current in a circuit breaker depends on the ambient temperature where the circuit breaker is placed. Ambient temperature is the temperature inside the enclosure or switchboard in which the circuit breakers are installed.

The reference temperature is 30 °C Ambient temperature: -5 °C ~ +40 °C.

Temperature	-10 °C	0 °C	10 °C	20 °C	30 °C	40 °C	50 °C	60 °C
Temperature compensation coefficient of rated current	1.20	1.15	1.10	1.05	1.00	0.95	0.90	0.85

4. Overall and mounting dimensions (mm)

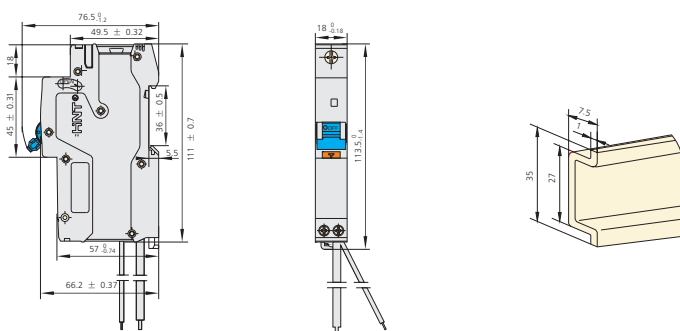



NB3LEU Residual Current Operated Circuit Breaker with Over-current Protection (Electronic)

1. General

1.1 Selection

Rated residual operating current

$I_{\Delta n} = 30 \text{ mA}$:

additional protection in the case of direct contact.

Tripping class

AC class – Tripping is ensured for sinusoidal, alternating currents, whether they be quickly applied or slowly increase.

Tripping curve

B curve (3-5 I_n) protection and control of the circuits against overloads and short-circuits; protection for people and big length cables in TN and IT systems.

C curve (5-10 I_n) protection and control of the circuits against overloads and short-circuits; protection for resistive and inductive loads with low inrush current.

1.2 Approvals and certificates

Detailed information, please refer to Certificates Table on the last page.

2. Ordering information

NB3LEU Curve B; 10KA; AC Type

★ NB3LEU, 1P+N



NB3LEU Curve C; 10KA; AC Type

★ NB3LEU, 1P+N



In (A)	Un (V)	I Δ n (mA)	Code
6	240	30	985599
10	240	30	985600
13	240	30	985601
16	240	30	985602
20	240	30	985603
25	240	30	985604
32	240	30	985605
40	240	30	985895

In (A)	Un (V)	I Δ n (mA)	Code
6	240	30	985606
10	240	30	985607
13	240	30	985608
16	240	30	985609
20	240	30	985610
25	240	30	985611
32	240	30	985612
40	240	30	985896

3. Technical data

3.1 Curves

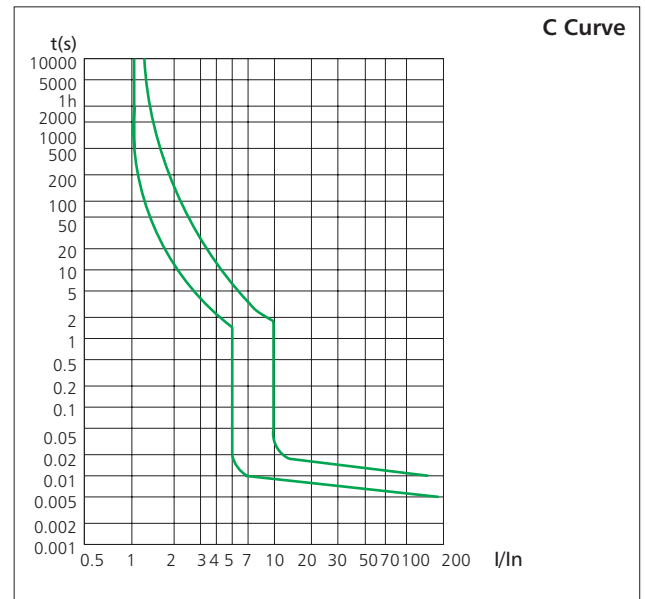
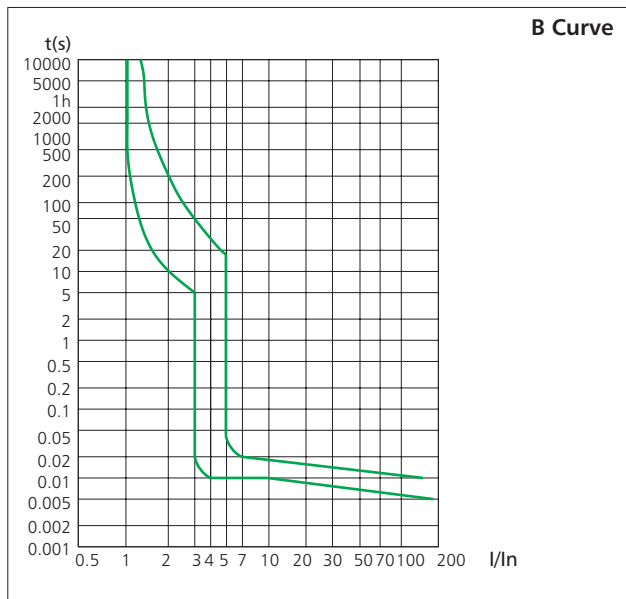

3.2

	Standard		IEC/EN 61009-1
Electrical features	Type (wave form of the earth leakage sensed)		AC
	Thermo-magnetic release characteristic		B, C
	Rated current I _n	A	6, 10, 13, 16, 20, 25, 32, 40
	Poles		1P+N
	Rated voltage U _e	V	240
	Rated sensitivity I _{Δn}	A	0.03
	Rated residual making and breaking capacity I _{Δm}	A	500
	Rated short-circuit capacity I _{cn}	A	10,000
	Break time under I _{Δn}	s	≤0.1
	Rated frequency	Hz	50/60
	Rated impulse withstand voltage (1.2/50)U _{imp}	V	4,000
	Dielectric TEST voltage at ind. Freq. for 1min	kV	2
	Insulation voltage U _i		500
	Pollution degree		2
Mechanical features	Electrical life		2,000
	Mechanical life		2,000
	Contact position indicator		Yes
	Protection degree		IP20
	Ambient temperature (with daily average ≤35°C)	°C	-5...+40 (Special application please refer to P55 for temperature compensation correction)
	Storage temperature	°C	-25...+70
Installation	Terminal connection type		Cable/U-type busbar/Pin-type busbar
	Terminal size top/bottom for cable	mm ²	16
		AWG	18-5
	Terminal size top/bottom for busbar	mm ²	10
		AWG	18-8
	Tightening torque	N*m	2
		In-lbs.	18
Mounting		On DIN rail EN 60715 (35mm) by means of fast clip device	
Connection		From bottom	

3.3 Temperature derating

The maximum permissible current in a circuit breaker depends on the ambient temperature where the circuit breaker is placed. Ambient temperature is the temperature inside the enclosure or switchboard in which the circuit breakers are installed.

The reference temperature is 30°C

Temperature	-10°C	0°C	10°C	20°C	30°C	40°C	50°C	60°C
Temperature compensation coefficient of rated current	1.20	1.15	1.10	1.05	1.00	0.95	0.90	0.85

4. Overall and mounting dimensions (mm)

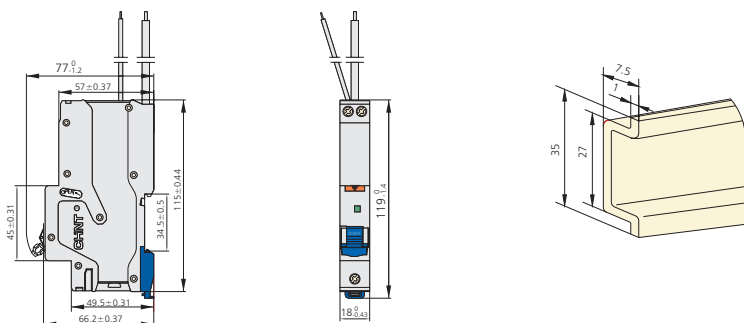



NBH8LE Residual Current Operated Circuit Breaker with over-current protection (Electronic)

1. General

1.1 Function

Personnel and fire protection
Cable and line protection against overload
and short-circuits.

1.2 Selection

$I_{\Delta n} = 30 \text{ mA}$: additional protection
in the case of direct contact.
C curve (5-10 I_n) protection and control of the circuits
against overloads and short-circuits; protection for
resistive and inductive loads with low inrush current.
AC class – Tripping is ensured for sinusoidal,
alternating currents, whether they be quickly applied
or slowly increase.

1.3 Approvals and certificates

Detailed information, please refer to Certificates Table
on the last page.



SAA

2. Ordering information

2.1 Technical parameters

Curve C

★ NBH8LE, 1P+N



In (A)	I _{Δn} (mA)	CTN	Order Code	
			Standard	RoHS
1	30	90	143111	970962
2	30	90	143112	970963
3	30	90	143113	970964
4	30	90	143114	970965
6	30	90	143115	970966
10	30	90	143116	970967
16	30	90	143117	970968
20	30	90	143118	970969
25	30	90	143119	970970
32	30	90	143120	970971
40	30	90	143121	970972

3. Technical data

3.1 Curves

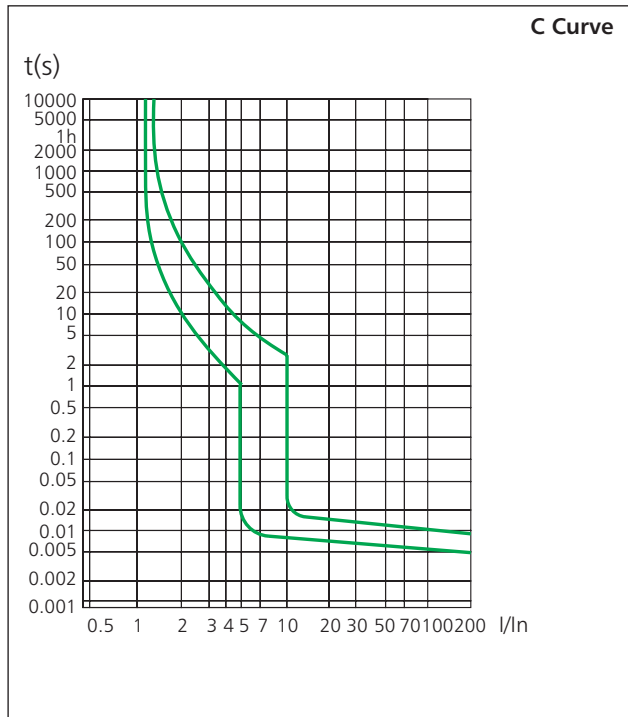

3.2

	Standard		IEC/EN 61009-1
Electrical features	Type (wave form of the earth leakage sensed)		AC
	Thermo-magnetic release characteristic		C
	Rated current I _n	A	1, 2, 3, 4, 6, 10, 16, 20, 25, 32, 40
	Poles		1P+N
	Rated voltage U _e	V	230
	Rated sensitivity I _{Δn}	A	0.03
	Rated residual making and breaking capacity I _{Δm}	A	500
	Rated short-circuit capacity I _{cn}	A	4,500
	Break time under I _{Δn}	s	≤0.1
	Rated frequency	Hz	50/60
	Rated impulse withstand voltage (1.2/50)U _{imp}	V	4,000
	Dielectric TEST voltage at ind. Freq. for 1 min	kV	2
	Insulation voltage U _i	V	300
	Pollution degree		2
	Mechanical features	Electrical life	
Mechanical life			20,000
Contact position indicator			Yes
Protection degree			IP20
Ambient temperature (with daily average ≤35°C)		°C	-5...+40 (Special application please refer to P64 for temperature compensation correction)
Storage temperature	°C	-25...+70	
Installation	Terminal connection type		Cable/Pin-type busbar
	Terminal size top/bottom for cable	mm ²	16
		AWG	18-5
	Terminal size top/bottom for busbar	mm ²	10
		AWG	18-8
	Tightening torque	N*m	2
		In-lbs.	11
Mounting		On DIN rail EN 60715 (35mm) by means of fast clip device	
Connection		From top	

3.3 Temperature derating

The maximum permissible current in a circuit breaker depends on the ambient temperature where the circuit breaker is placed. Ambient temperature is the temperature inside the enclosure or switchboard in which the circuit breakers are installed.

The reference temperature is 30°C

Temperature	-10°C	0°C	10°C	20°C	30°C	40°C	50°C	60°C
Temperature compensation coefficient	1.20	1.15	1.10	1.05	1.00	0.95	0.90	0.85

4. Overall and mounting dimensions (mm)

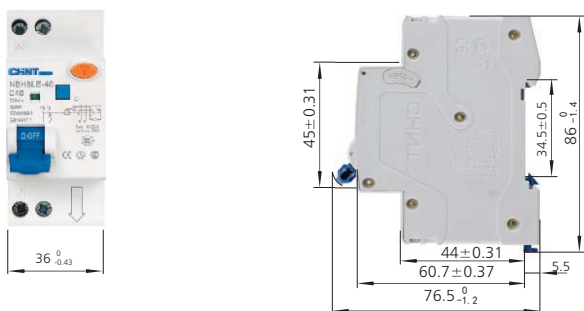



DZ158LE Residual Current Operated Circuit Breaker

1. General

1.1 Function

Personnel and fire protection
Cable and line protection against overload and short-circuits.

1.2 Selection

$I_{\Delta n} \leq 30 \text{ mA}$: additional protection
in the case of direct contact.

$I_{\Delta n} \leq 300 \text{ mA}$: preventative fire protection
in the case of ground fault currents.

AC class – Tripping is ensured for sinusoidal,
alternating currents, whether they be quickly applied
or slowly increase.

1.3 Approvals and certificates

Detailed information, please refer to Certificates Table
on the last page.

2. Ordering information

★ DZ158LE, 1P+N



In (A)	I _{Δn} (mA)	CTN	Order Code	
			Standard	RoHS
63	30	36	145401	970013
63	100	36	145402	970014
63	300	36	145403	970015
80	30	36	145404	970016
80	100	36	145405	970017
80	300	36	145406	970018
100	30	36	145407	970019
100	100	36	145408	970020
100	300	36	145409	970021

★ DZ158LE, 2P



In (A)	I _{Δn} (mA)	CTN	Order Code	
			Standard	RoHS
63	30	27	145410	970022
63	100	27	145411	970023
63	300	27	145412	970024
80	30	27	145413	970025
80	100	27	145414	970026
80	300	27	145415	970027
100	30	27	145416	970028
100	100	27	145417	970029
100	300	27	145418	970030

★ DZ158LE, 3P



In (A)	I _{Δn} (mA)	CTN	Order Code	
			Standard	RoHS
63	30	18	145419	970031
63	100	18	145420	970032
63	300	18	145421	970033
80	30	18	145422	970034
80	100	18	145423	970035
80	300	18	145424	970036
100	30	18	145425	970037
100	100	18	145426	970038
100	300	18	145427	970039

★ DZ158LE, 3P+N



In (A)	I _{Δn} (mA)	CTN	Order Code	
			Standard	RoHS
63	30	18	145428	970040
63	100	18	145429	970041
63	300	18	145430	970042
80	30	18	145431	970043
80	100	18	145432	970044
80	300	18	145433	970045
100	30	18	145434	970046
100	100	18	145435	970047
100	300	18	145436	970048

★ DZ158LE, 4P



In (A)	I _{Δn} (mA)	CTN	Order Code	
			Standard	RoHS
63	30	18	145437	970049
63	100	18	145438	970050
63	300	18	145439	970051
80	30	18	145440	970052
80	100	18	145441	970053
80	300	18	145442	970054
100	30	18	145443	970055
100	100	18	145444	970056
100	300	18	145445	970057

3. Technical data

3.1 Curves

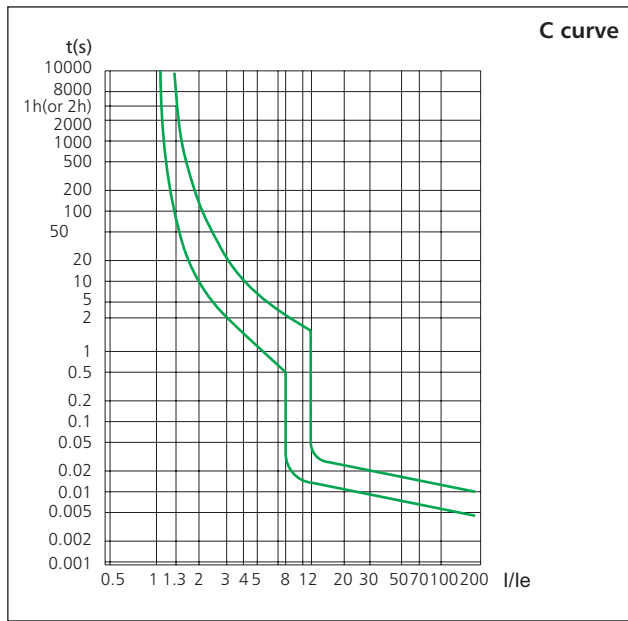

3.2

	Standard		IEC/EN 60947-2
Electrical features	Type (wave form of the earth leakage sensed)		AC
	Thermo-magnetic release characteristic		8-12In
	Rated current In	A	63, 80, 100
	Poles		1P+N, 2P, 3P, 3P+N, 4P
	Rated voltage Ue	V	230/400
	Rated sensitivity IΔn	A	0.03, 0.1, 0.3
	Rated residual making and breaking capacity IΔm	A	2,000
	Rated short-circuit capacity Icn	A	6,000
	Break time under IΔn	s	≤0.1
	Rated frequency	Hz	50
	Rated impulse withstand voltage (1.2/50)Uimp	V	4,000
	Dielectric TEST voltage at ind. Freq. for 1min	kV	2.0
	Insulation voltage Ui	V	500
	Pollution degree		3
Mechanical features	Electrical life		1,500
	Mechanical life		8,500
	Contact position indicator		Yes
	Protection degree		IP20
	Ambient temperature (with daily average ≤35°C)	°C	-5...+40 (Special application please refer to P68 for temperature compensation correction)
Storage temperature	°C	-25...+70	
Installation	Terminal connection type		Cable/Pin-type busbar
	Terminal size top/bottom for cable	mm ²	16-50
		AWG	6-1/0
	Terminal size top/bottom for busbar	mm ²	16-35
		AWG	6-2
	Tightening torque	N*m	3.5
		In-lbs.	31
Mounting Connection		On DIN rail EN 60715 (35mm) by means of fast clip device From top	

3.3 Temperature derating

The maximum permissible current in a circuit breaker depends on the ambient temperature where the circuit breaker is placed. Ambient temperature is the temperature inside the enclosure or switchboard in which the circuit breakers are installed.

The reference temperature is 30°C

Rated current In (A)	Temperature compensation coefficient under various operational temperature							
	-10°C	0°C	10°C	20°C	30°C	40°C	50°C	60°C
63	1.275	1.215	1.15	1.075	1.00	0.915	0.825	0.735
80	1.27	1.205	1.135	1.27	1.00	0.925	0.845	0.755
100	1.275	1.21	1.135	1.075	1.00	0.925	0.845	0.755

4. Overall and mounting dimensions (mm)

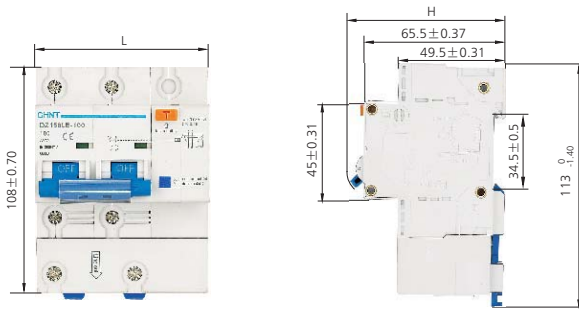

Number of poles	1P+N	2P	3P	3P+N	4P
L (mm)	54 ⁰ _{-0.74}	81 ⁰ _{-0.87}	108 ⁰ _{-1.40}	108 ⁰ _{-1.40}	135 ⁰ _{-1.60}
H (mm)	73.5 ⁰ _{-1.2}	78.5 ⁰ _{-1.2}	78.5 ⁰ _{-1.2}	78.5 ⁰ _{-1.2}	78.5 ⁰ _{-1.2}

**XF9 (Auxiliary Contact for
NB1, NBH8, NB1L, NB3LE, NBH8LE)****1. General**

Indication of the position of the device's contacts.
To be mounted on the left side of the MCBs/RCBOs
thanks to the special pin.



2. Technical data

Standard		IEC/EN 60947-5-1		
Electrical features	Rated value		UN (V)	In (A)
			AC415 50/60Hz	3
			AC240 50/60Hz	6
			DC130	1
			DC48	2
		DC24	6	
	Configurations		1N/O+1N/C	
Rated impulse withstand voltage (1.2/50)Uimp	V	4,000		
Dielectric TEST voltage at ind. Freq. for 1min	kV	2		
Insulation voltage Ui	V	500		
Pollution degree		2		
Mechanical features	Electrical life		6,050	
	Mechanical life		10,000	
	Protection degree		IP20	
	Ambient temperature (with daily average ≤35°C)	°C	-5...+40	
	Storage temperature	°C	-25...+70	
Installation	Terminal connection type		Cable	
	Terminal size top/bottom for cable	mm ²	2.5	
		AWG	18-14	
	Tightening torque	N*m	0.8	
In-lbs.		7		

3. Ordering information

Model	Operational voltage (V)	Rated current (A)	Order Code	
			Standard	RoHS
XF9	AC 415/AC240/DC130/DC48/DC24	3/6/1/2/6	131401	971273

4. Overall and mounting dimensions (mm)

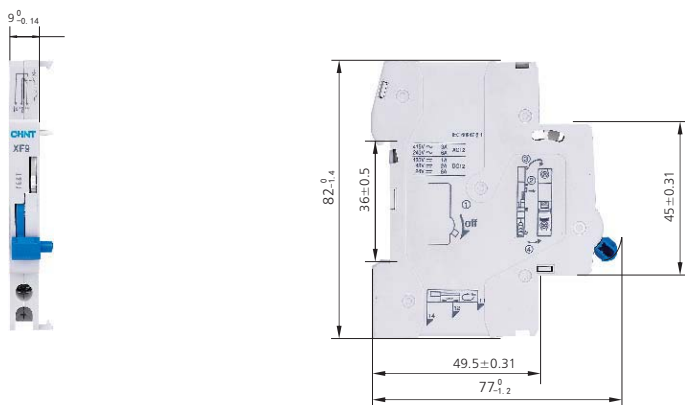



XF9J (Alarm Auxiliary Contact for NB1, NBH8, NB1L, NB3LE, NBH8LE)

1.General

1.1 Indication of the position of the device's contacts only after the automatic release of the MCBs and RCBOs due to an overload or a short-circuit.

1.2 To be mounted on the left side of the MCBs/RCBOs thanks to the special pin.

2. Technical data

Standard		IEC/EN 60947-5-1	
Electrical features	Rated value	UN (V)	In (A)
		AC415 50/60Hz	3
		AC240 50/60Hz	6
		DC130	1
		DC48	2
		DC24	6
Electrical features	Configurations	1N/O+1N/C	
	Rated impulse withstand voltage (1.2/50)Uimp	V	4,000
	Dielectric TEST voltage at ind. Freq. for 1min	kV	2
	Insulation voltage Ui	V	500
	Pollution degree		2
Mechanical features	Electrical life		6,050
	Mechanical life		10,000
	Protection degree		IP20
	Ambient temperature (with daily average ≤ 35°C)	°C	-5...+40
	Storage temperature	°C	-25...+70
Installation	Terminal connection type		Cable
	Terminal size top/bottom for cable	mm ²	2.5
		AWG	18-14
	Tightening torque	N*m	0.8
In-lbs.		7	

3. Ordering information

Model	Operational voltage (V)	Rated current(A)	Order Code	
			Standard	RoHS
XF9J	AC 415/240; DC 130/48/24	3/6; 1/2/6	131413	985540

4. Overall and mounting dimensions (mm)

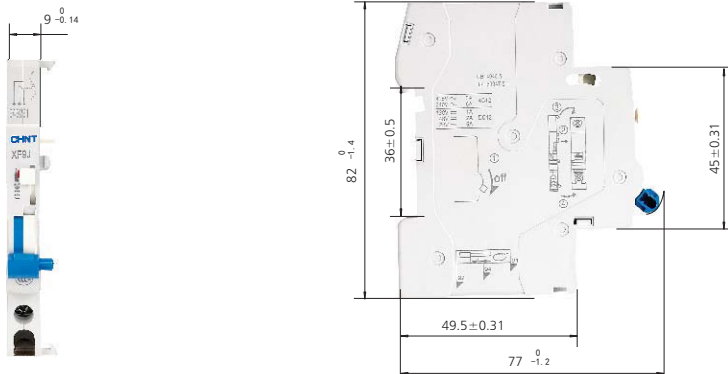



S9 (Shunt Release for NB1, NBH8, NB1L, NB3LE, NBH8LE)

1. General

1.1 Remote opening of the device when a voltage is applied.

1.2 To be mounted on the left side of the MCBs/RCBOs thanks to the special pin.

2. Technical data

Standard		IEC/EN 60947-5-1	
Electrical features	Rated voltage U_s	V	AC230/400 50/60Hz
			DC24
			DC48
	Rated impulse withstand voltage (1.2/50) U_{imp}	V	4,000
	Dielectric TEST voltage at ind. Freq. for 1min	kV	2
	Insulation voltage U_i	V	500
Mechanical features	Pollution degree		2
	Electrical life		4,000
	Mechanical life		4,000
	Protection degree		IP20
	Ambient temperature (with daily average $\leq 35^\circ\text{C}$)	$^\circ\text{C}$	-5... +40
Storage temperature	$^\circ\text{C}$	-25... +70	
Installation	Terminal connection type		Cable
	Terminal size top/bottom for cable	mm^2	2.5
		AWG	18-14
	Tightening torque	N*m	0.8
In-lbs.		7	

3. Ordering information

Model	Operational voltage (V)	Order Code	
		Standard	RoHS
S9	AC 230/AC 400	131406	-
S9	DC 24	131408	-
S9	DC 48	131409	-

Note: Products marked with * are under development

4. Overall and mounting dimensions (mm)

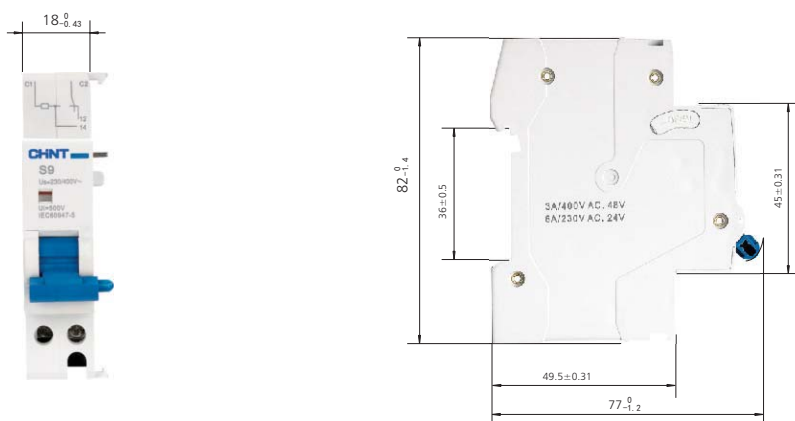



V9 (Under Voltage Release for NB1, NBH8, NB1L, NB3LE, NBH8LE)

1.General

1.1 Protection of the load in the event of a voltage drop (between 70% and 35% of its rated value)

1.2 Positive safety (device's tripping when the voltage is disconnected) emergency stop by means of a button.

1.3 To be mounted on the left side of the MCBs/RCBOs thanks to the special pin.

2. Technical data

Standard		IEC/EN 60947-5-1	
Electrical features	Rated voltage U_s	V	AC230 50/60Hz
	Optional voltage of release		70-35% U_e , reliable operation
			<35% U_e , prevent breaker from making
			85~110% U_e , reliable operation
	Rated impulse withstand voltage (1.2/50) U_{imp}	V	4,000
	Dielectric TEST voltage at ind. Freq. for 1min	kV	2
	Insulation voltage U_i	V	500
Pollution degree		2	
Mechanical features	Electrical life		4,000
	Mechanical life		4,000
	Protection degree		IP20
	Ambient temperature (with daily average $\leq 35^\circ\text{C}$)	$^\circ\text{C}$	-5...+40
	Storage temperature	$^\circ\text{C}$	-25...+70
Installation	Terminal connection type		Cable
	Terminal size top/bottom for cable	mm^2	2.5
		AWG	18-14
	Tightening torque	N*m	0.8
In-lbs.		7	

3. Ordering information

Model	Operational voltage (V)	Order Code	
		Standard	RoHS
V9	AC 230	131410	971275

4. Overall and mounting dimensions (mm)

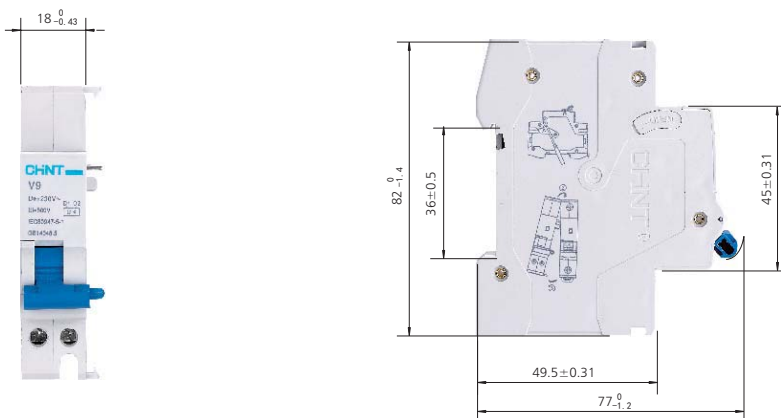



AX-1 (Auxiliary Contact for DZ158, DZ158LE)

1. General

- 1.1 Indication of the position of the device's contacts.
- 1.2 To be mounted on the left side of the MCBs/RCBOs thanks to the special pin.

2. Technical data

Standard		IEC/EN 60947-5-1	
Rated voltage U_s	V	U_n (V)	I_n (A)
		AC415 50/60Hz	3
		DC125	1
Configurations		1N/O+1N/C	
Electrical features	Rated impulse withstand voltage (1.2/50) U_{imp}	V	4,000
	Dielectric TEST voltage at ind. Freq. for 1min	kV	2
	Insulation voltage U_i	V	500
	Pollution degree		2
	Electrical life		6,050
Mechanical features	Mechanical life		10,000
	Protection degree		IP20
	Ambient temperature (with daily average $\leq 35^\circ\text{C}$)	$^\circ\text{C}$	-5...+40
	Storage temperature	$^\circ\text{C}$	-25...+70
	Terminal connection type		Cable
Installation	Terminal size top/bottom for cable	mm^2	2.5
		AWG	18-14
	Tightening torque	N*m	0.8
		In-lbs.	7

3. Ordering information



Model	Order Code
AX-1	985483

4. Overall and mounting dimensions (mm)

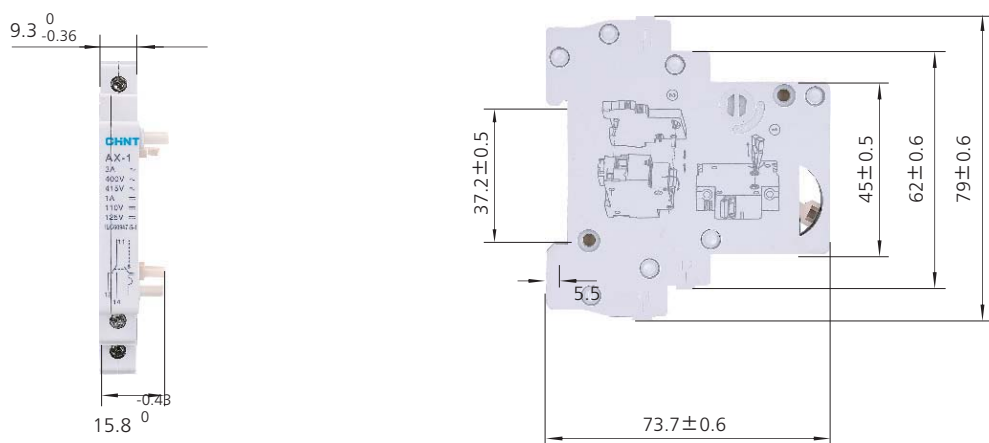

NH2 Switch Disconnect

1. General

1.1 In the open position, It complies with the requirements of the isolating function.

1.2 It is designed match DZ series MCBs/RCBOs.

1.3 Approvals and certificates
 Detailed information, please refer to Certificates Table on the last page.



RCC

2. Ordering information

★ NH2, 1P



Ie (A)	Ue (V~)	CTN	Order Code	
			Standard	RoHS
32	230	144	153201	970998
63	230	144	153202	970999
100	230	144	153203	971000

★ NH2, 2P



Ie (A)	Ue (V~)	CTN	Order Code	
			Standard	RoHS
32	400	72	153204	971001
63	400	72	153205	971002
100	400	72	153206	971003

★ NH2, 3P



Ie (A)	Ue (V~)	CTN	Order Code	
			Standard	RoHS
32	400	48	153207	971004
63	400	48	153208	971005
100	400	48	153209	971006

★ NH2, 4P



Ie (A)	Ue (V~)	CTN	Order Code	
			Standard	RoHS
32	400	36	153210	971007
63	400	36	153211	971008
100	400	36	153212	971009

3. Technical data

	Standard		IEC/EN 60947-3
Electrical features	Rated voltage Ue	V	230/400~240/415
	Rated current Ie	A	32, 63, 100
	Rated frequency	Hz	50/60
	Rated impulse withstand voltage (1.2/50)Uimp	V	4,000
	Rated short-time withstand current Icw		12Ie, 1s
	Rated making and breaking capacity		3Ie, 1.05Ue, cosφ=0.65
	Rated short circuit making capacity		20Ie, t=0.1s
	Dielectric test voltage at ind. Freq. for 5s	kV	2
	Insulation voltage Ui	V	500
	Pollution degree		2
Utilization category		AC-22A	
Mechanical features	Electrical life		1,500
	Mechanical life		8,500
	Protection degree		IP20
	Ambient temperature (with daily average ≤35°C)	°C	-5...+40
	Storage temperature	°C	-25...+70
Installation	Terminal connection type		Cable/Pin-type busbar
	Terminal size top/bottom for cable	mm ²	50
		AWG	18-1/0
	Terminal size top/bottom for busbar	mm ²	25
		AWG	18-3
	Tightening torque	N*m	2.5
In-lbs.		22	
Connection		From top and bottom	

4. Overall and mounting dimensions (mm)

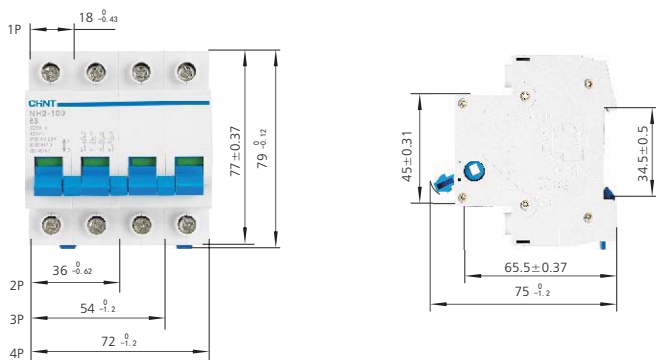



NH4 Switch Disconnecter

1. General

1.1 In the open position, It complies with the requirements of the isolating function.

1.2 It is designed match NB series MCBs/RCBOs.

1.3 Approvals and certificates

Detailed information, please refer to Certificates Table on the last page.



2. Ordering information

★ NH4, 1P



★ NH4, 2P



Ie (A)	Ue (V~)	CTN	Order Code	
			Standard	RoHS
32	230	180	153213	971014
63	230	180	153214	971015
100	230	180	153215	971016
125	230	180	-	983281

Ie (A)	Ue (V~)	CTN	Order Code	
			Standard	RoHS
32	400	90	153216	971017
63	400	90	153217	971018
100	400	90	153218	971019
125	400	90	-	983282

★ NH4, 3P



★ NH4, 4P



Ie (A)	Ue (V~)	CTN	Order Code	
			Standard	RoHS
32	400	60	153219	971020
63	400	60	153220	971021
100	400	60	153221	971022
125	400	60	-	983283

Ie (A)	Ue (V~)	CTN	Order Code	
			Standard	RoHS
32	400	45	153222	971023
63	400	45	153223	971024
100	400	45	153224	971025
125	400	45	-	983284

3. Technical features

	Standard		IEC/EN 60947-3
Electrical features	Rated voltage Ue	V	230/400~240/415
	Rated current Ie	A	32, 63, 100, 125
	Rated frequency	Hz	50/60
	Rated impulse withstand voltage (1.2/50)Uimp	V	4,000
	Rated short-time withstand current Icw		12Ie, 1s
	Rated making and breaking capacity		3Ie, 1.05Ue, cosφ=0.65
	Rated short circuit making capacity		20Ie, t=0.1s
	Dielectric test voltage at ind. Freq. for 5s	kV	2
	Insulation voltage Ui	V	500
	Pollution degree		2
Utilization category		AC-22A	
Mechanical features	Electrical life		1,500
	Mechanical life		8,500
	Protection degree		IP20
	Ambient temperature (with daily average ≤35°C)	°C	-5...+40
	Storage temperature	°C	-25...+70
Installation	Terminal connection type		Cable/Pin-type busbar/U-type busbar
	Terminal size top/bottom for cable	mm ²	50
		AWG	18-1/0
	Terminal size top/bottom for busbar	mm ²	35
		AWG	18-2
	Tightening torque	N*m	2.5
		In-lbs.	22
Connection		From top and bottom	

4. Overall and mounting dimensions (mm)

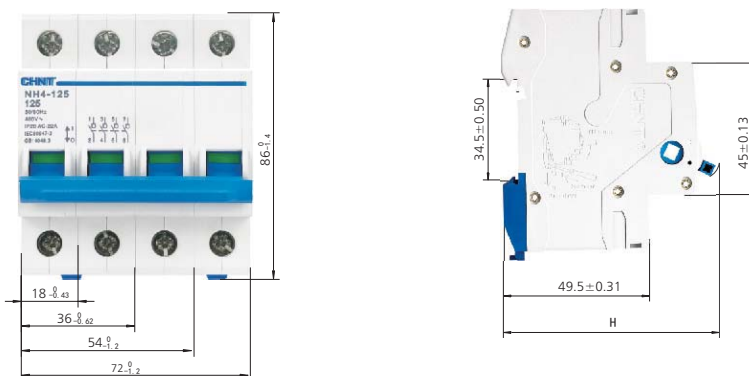

Number of poles	1P	2P~4P
H (mm)	74 ⁰ _{-1.2}	78 ⁰ _{-1.2}

NU6 Low-voltage Surge Arrester NU6- I

1. General

1.1 Certificates: international certificates are under proceeding;

1.2 Electric ratings: 230/400V, AC50/60Hz, 3-phase;

1.3 Application: Protect electric system and on-loading electrical apparatus from thunder and instantaneous over-voltage;

1.4 Standard: IEC/EN 61643-1



2. Technical data

2.1 Technical parameters

Model	Shock current limp		Max. continuous operational voltage U_c (V~)	Level of protection U_p (kV)	Nominal discharge current I_n (8/20 μ s) (kA)
	I_{peak} (10/350 μ s) (kA)	Load Q A_s			
NU6- I	15	7.5	275	4.0	25
			320	4.0	
			385	4.0	
			440	4.0	
NU6- I	25	12.5	275	4.0	25
			320	4.0	
			385	4.0	
			440	4.0	
NU6- I	40	20	275	4.0	50
			320	4.0	
			385	4.0	

3. Overall and mounting dimensions (mm)

NU6- I (15kA, 25kA)

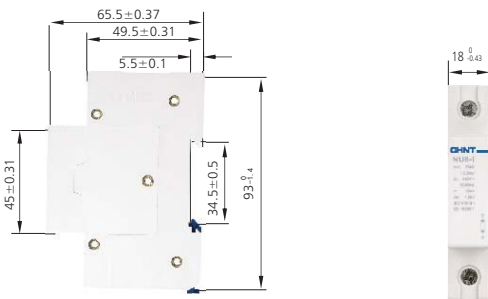

4. Ordering information

Model	Shock current limp peak (10/350 μ s) (kA)	Max. continuous operational voltage U_c (V~)	CTN	Order code	
				Standard	RoHS
NU6- I	15	275	192	152001	-
NU6- I	15	320	192	152002	-
NU6- I	15	385	192	152003	-
NU6- I	15	440	192	152004	-
NU6- I	25	275	192	152005	-
NU6- I	25	320	192	152006	-
NU6- I	25	385	192	152007	-
NU6- I	25	440	192	152008	-
NU6- I	40	275	96	152009	-
NU6- I	40	320	96	152010	-
NU6- I	40	385	96	152011	-
NU6- I	40	440	96	152012	-

NU6- I (40kA)

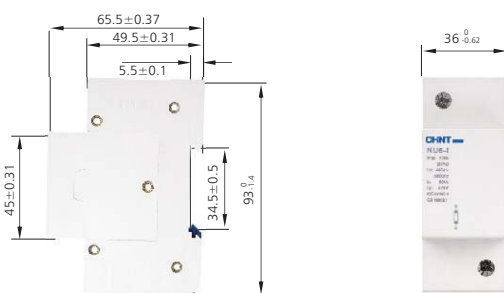

NU6-II

1. General

- 1.1 Certificates: international certificates are under proceeding;
- 1.2 Number of poles: 1, 2,3, 4;
- 1.3 Electric ratings: 230/400V, AC50/60Hz;
- 1.4 Application: Protect electric system and on-loading electrical apparatus from thunder and instantaneous over-voltage;
- 1.5 Standard: IEC/EN 61643-1

2. Technical data

Model	Max. continuous operational voltage U_c (V~)	Level of protection U_p (kV)	Nominal discharge current I_n (8/20 μ s) (kA)	Maximum discharge current I_{max} (8/20 μ s) (kA)	Mounting category of protected apparatus
NU6-II	275	1.2	5	15	I, II, III
	320	1.5			I, II, III
	385	1.8			I, II, III
	460	2.0			II, III
	510	2.5			II, III
	550	3.0			II, III
NU6-II	275	1.2	15	40	I, II, III
	320	1.5			I, II, III
	385	1.8			II, III
	460	2.0			II, III
	510	2.5			II, III
	550	3.0			III
NU6-II	275	1.2	25	60	I, II, III
	320	1.5			II, III
	385	1.8			II, III
	460	2.0			II, III
	510	2.5			III
	550	3.0			III
NU6-II	275	1.2	40	100	II, III
	320	1.5			II, III
	385	1.8			II, III
	460	2.0			III
	510	2.5			III
	550	3.0			III

Auxiliary	Configurations	Rated voltage U_n (V)	Rated current I_n (A)
contact	INO+INC	AC125	3

3. How to select surge protectors

- a. The voltage should be $\leq U_c$;
- b. $U_p <$ maximum impulse withstands;
- c. Different protectors should be selected according to various grounding system and protection mode.

Model	Max. continuous operational voltage U_c (V~)	Applicable grounding system	Protection mode	Circuits	Number of poles
NU6-II	275	TT	L-N	1 phase, 3 phase 4 wire	1
		TN-S	L-PE, N-PE, L-N	1 phase, 3 phase 5 wire	1,2,3,4
		TN-C	L-PE	1 phase, 3 phase 4 wire	1,2,3
	320	TT	L-N	1 phase, 3 phase 4 wire	1
		TN-S	L-PE, N-PE, L-N	1 phase, 3 phase 5 wire	1,2,3,4
		TN-C	L-PE	1 phase, 3 phase 4 wire	1,2,3
	385	TT	L-PE, N-PE, L-N	1 phase, 3 phase 4 wire	1,2,3,4
		TN-S	L-PE, N-PE, L-N	1 phase, 3 phase 5 wire	1,2,3,4
		TN-C	L-PE	1 phase, 3 phase 4 wire	1,2,3
	460	TT	L-PE, N-PE, L-N, L-L	1 phase, 3 phase 4 wire	1,2,3,4
		TN-S	L-PE, N-PE, L-N, L-L	1 phase, 3 phase 5 wire	1,2,3,4
		TN-C	L-PE, L-L	1 phase, 3 phase 4 wire	1,2,3
		IT	L-PE, N-PE, L-L	1 phase, 3 phase 3/4 wire	1,2,3,4
		TT	L-PE, N-PE, L-N, L-L	1 phase, 3 phase 4 wire	1,2,3,4
		TN-S	L-PE, N-PE, L-N, L-L	1 phase, 3 phase 5 wire	1,2,3,4
	510	TN-C	L-PE, L-L	1 phase, 3 phase 4 wire	1,2,3
		IT	L-PE, N-PE, L-L	1 phase, 3 phase 3/4 wire	1,2,3,4
		TT	L-PE, N-PE, L-N, L-L	1 phase, 3 phase 4 wire	1,2,3,4
	550	TN-S	L-PE, N-PE, L-N, L-L	1 phase, 3 phase 5 wire	1,2,3,4
		TN-C	L-PE, L-L	1 phase, 3 phase 4 wire	1,2,3
		IT	L-PE, N-PE, L-L	1 phase, 3 phase 3/4 wire	1,2,3,4

4. Functions

4.1 The product is composed of two independent components: removable protective module 4 and base 2;

4.2 When the product is damaged, the part 3 will indicate; please replace the removable protective module 4 at once and there is no need to cutoff the circuits;

4.3 The part 1 is for maximum continuous operational voltage indication as well as avoiding replacement with wrong module.

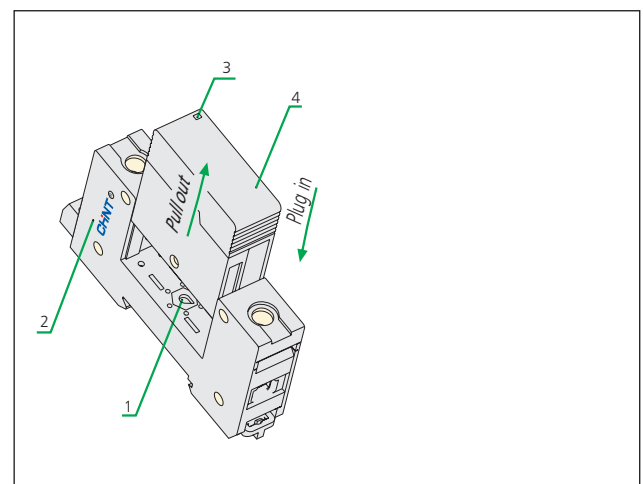

5. Overall and mounting dimensions (mm)

NU6-II/F (5, 15, 25kA) with remote control port

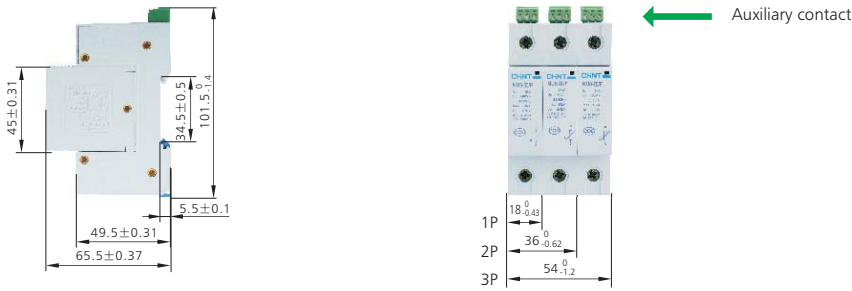

NU6-II (5, 15, 25kA) without remote control port

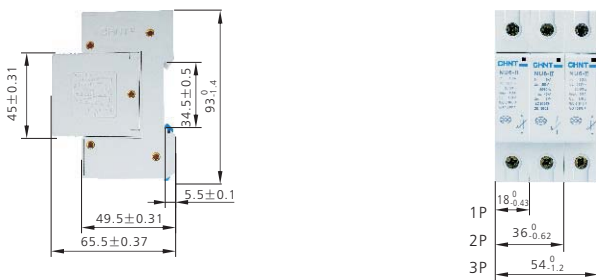

NU6-II/F (40kA) with remote control port

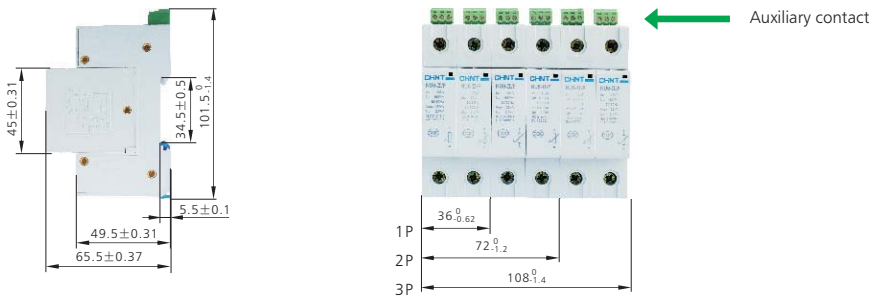

NU6-II/F (40kA) without remote control port

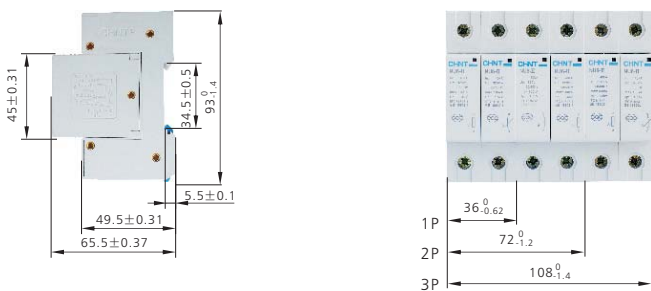

6. Ordering information

★ NU6- II 1P

Nominal discharge current (kA)	Max. continuous operational voltage U _c (V~)	With remote control port	CTN	Order code	
				Standard	RoHS
5	275	No	144	152101	-
5	320	No	144	152102	-
5	385	No	144	152103	-
5	460	No	144	152104	-
5	510	No	144	152105	-
5	550	No	144	152106	-
15	275	No	144	152107	-
15	320	No	144	152108	-
15	385	No	144	152109	-
15	460	No	144	152110	-
15	510	No	144	152111	-
15	550	No	144	152112	-
25	275	No	144	152113	-
25	320	No	144	152114	-
25	385	No	144	152115	-
25	460	No	144	152116	-
25	510	No	144	152117	-
25	550	No	144	152118	-
40	275	No	72	152119	-
40	320	No	72	152120	-
40	385	No	72	152121	-
40	460	No	72	152122	-
40	510	No	72	152123	-
40	550	No	72	152124	-

★ NU6- II/F 1P

Nominal discharge current (kA)	Max. continuous operational voltage U _c (V~)	With remote control port	CTN	Order code	
				Standard	RoHS
5	275	Yes	144	152125	-
5	320	Yes	144	152126	-
5	385	Yes	144	152127	-
5	460	Yes	144	152128	-
5	510	Yes	144	152129	-
5	550	Yes	144	152130	-
15	275	Yes	144	152131	-
15	320	Yes	144	152132	-
15	385	Yes	144	152133	-
15	460	Yes	144	152134	-
15	510	Yes	144	152135	-
15	550	Yes	144	152136	-
25	275	Yes	144	152137	-
25	320	Yes	144	152138	-
25	385	Yes	144	152139	-
25	460	Yes	144	152140	-
25	510	Yes	144	152141	-
25	550	Yes	144	152142	-
40	275	Yes	72	152143	-
40	320	Yes	72	152144	-
40	385	Yes	72	152145	-
40	460	Yes	72	152146	-
40	510	Yes	72	152147	-
40	550	Yes	72	152148	-

★ NU6-II 2P

Nominal discharge current (kA)	Max. continuous operational voltage U _c (V~)	With remote control port	CTN	Order code	
				Standard	RoHS
5	275	No	72	152149	-
5	320	No	72	152150	-
5	385	No	72	152151	-
5	460	No	72	152152	-
5	510	No	72	152153	-
5	550	No	72	152154	-
15	275	No	72	152155	-
15	320	No	72	152156	-
15	385	No	72	152157	-
15	460	No	72	152158	-
15	510	No	72	152159	-
15	550	No	72	152160	-
25	275	No	72	152161	-
25	320	No	72	152162	-
25	385	No	72	152163	-
25	460	No	72	152164	-
25	510	No	72	152165	-
25	550	No	72	152166	-
40	275	No	36	152167	-
40	320	No	36	152168	-
40	385	No	36	152169	-
40	460	No	36	152170	-
40	510	No	36	152171	-
40	550	No	36	152172	-

★ NU6-II/F 2P

Nominal discharge current (kA)	Max. continuous operational voltage U _c (V~)	With remote control port	CTN	Order code	
				Standard	RoHS
5	275	Yes	72	152173	-
5	320	Yes	72	152174	-
5	385	Yes	72	152175	-
5	460	Yes	72	152176	-
5	510	Yes	72	152177	-
5	550	Yes	72	152178	-
15	275	Yes	72	152179	-
15	320	Yes	72	152180	-
15	385	Yes	72	152181	-
15	460	Yes	72	152182	-
15	510	Yes	72	152183	-
15	550	Yes	72	152184	-
25	275	Yes	72	152185	-
25	320	Yes	72	152186	-
25	385	Yes	72	152187	-
25	460	Yes	72	152188	-
25	510	Yes	72	152189	-
25	550	Yes	72	152190	-
40	275	Yes	36	152191	-
40	320	Yes	36	152192	-
40	385	Yes	36	152193	-
40	460	Yes	36	152194	-
40	510	Yes	36	152195	-
40	550	Yes	36	152196	-

★ NU6- II 3P

Nominal discharge current (kA)	Max. continuous operational voltage U_c (V~)	With remote control port	CTN	Order code	
				Standard	RoHS
5	275	No	48	152197	-
5	320	No	48	152198	-
5	385	No	48	152199	-
5	460	No	48	152200	-
5	510	No	48	152201	-
5	550	No	48	152202	-
15	275	No	48	152203	-
15	320	No	48	152204	-
15	385	No	48	152205	-
15	460	No	48	152206	-
15	510	No	48	152207	-
15	550	No	48	152208	-
25	275	No	48	152209	-
25	320	No	48	152210	-
25	385	No	48	152211	-
25	460	No	48	152212	-
25	510	No	48	152213	-
25	550	No	48	152214	-
40	275	No	24	152215	-
40	320	No	24	152216	-
40	385	No	24	152217	-
40	460	No	24	152218	-
40	510	No	24	152219	-
40	550	No	24	152220	-

★ NU6- II/F 3P

Nominal discharge current (kA)	Max. continuous operational voltage U_c (V~)	With remote control port	CTN	Order code	
				Standard	RoHS
5	275	Yes	48	152221	-
5	320	Yes	48	152222	-
5	385	Yes	48	152223	-
5	460	Yes	48	152224	-
5	510	Yes	48	152225	-
5	550	Yes	48	152226	-
15	275	Yes	48	152227	-
15	320	Yes	48	152228	-
15	385	Yes	48	152229	-
15	460	Yes	48	152230	-
15	510	Yes	48	152231	-
15	550	Yes	48	152232	-
25	275	Yes	48	152233	-
25	320	Yes	48	152234	-
25	385	Yes	48	152235	-
25	460	Yes	48	152236	-
25	510	Yes	48	152237	-
25	550	Yes	48	152238	-
40	275	Yes	24	152239	-
40	320	Yes	24	152240	-
40	385	Yes	24	152241	-
40	460	Yes	24	152242	-
40	510	Yes	24	152243	-
40	550	Yes	24	152244	-

★ NU6- II 4P

Nominal discharge current (kA)	Max. continuous operational voltage U _c (V~)	With remote control port	CTN	Order code	
				Standard	RoHS
5	275	No	36	152245	-
5	320	No	36	152246	-
5	385	No	36	152247	-
5	460	No	36	152248	-
5	510	No	36	152249	-
5	550	No	36	152250	-
15	275	No	36	152251	-
15	320	No	36	152252	-
15	385	No	36	152253	-
15	460	No	36	152254	-
15	510	No	36	152255	-
15	550	No	36	152256	-
25	275	No	36	152257	-
25	320	No	36	152258	-
25	385	No	36	152259	-
25	460	No	36	152260	-
25	510	No	36	152261	-
25	550	No	36	152262	-
40	275	No	12	152263	-
40	320	No	12	152264	-
40	385	No	12	152265	-
40	460	No	12	152266	-
40	510	No	12	152267	-
40	550	No	12	152268	-

★ NU6- II/F 4P

Nominal discharge current (kA)	Max. continuous operational voltage U _c (V~)	With remote control port	CTN	Order code	
				Standard	RoHS
5	275	Yes	36	152269	-
5	320	Yes	36	152270	-
5	385	Yes	36	152271	-
5	460	Yes	36	152272	-
5	510	Yes	36	152273	-
5	550	Yes	36	152274	-
15	275	Yes	36	152275	-
15	320	Yes	36	152276	-
15	385	Yes	36	152277	-
15	460	Yes	36	152278	-
15	510	Yes	36	152279	-
15	550	Yes	36	152280	-
25	275	Yes	36	152281	-
25	320	Yes	36	152282	-
25	385	Yes	36	152283	-
25	460	Yes	36	152284	-
25	510	Yes	36	152285	-
25	550	Yes	36	152286	-
40	275	Yes	12	152287	-
40	320	Yes	12	152288	-
40	385	Yes	12	152289	-
40	460	Yes	12	152290	-
40	510	Yes	12	152291	-
40	550	Yes	12	152292	-

NU6-III

1. General



- 1.1 Certificates: international certificates are under proceeding;
- 1.2 Electric ratings: Single phase power distribution and control system of AC50/60Hz, 230V;
- 1.3 Short circuit current: up to 10kA (8/20 μ s);
- 1.4 Application: Protect electric system and on-loading electrical apparatus from lightning and instantaneous over-voltage;
- 1.5 Standard: IEC/EN 61643-1

2. Technical data

Model	Uoc (1.2/50 μ s) (kV)	Short circuit current Isc (8/20us)(KA)	Max. continuous operational voltage Uc (V~)	Level of protection Up (kV)
NU6-III	2	1	275	1.5
			320	1.5
			385	1.5
	3	1.5	275	1.5
			320	1.5
			385	1.5
	4	2	275	1.5
			320	1.5
			385	1.5
	6	3	275	1.5
			320	1.5
			385	1.5
10	5	275	1.5	
		320	1.5	
		385	1.5	
20	10	275	1.5	
		320	1.5	

Auxiliary	Configurations	Rated voltage Un(V)	Rated current In(A)
contact	INO+INC	AC125	3

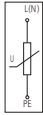
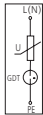
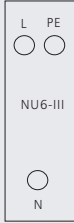
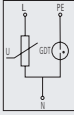
3. Type and circuit diagram

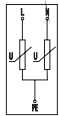
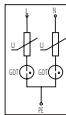
Model	Type	Circuit diagram	
NU6-III	L/N-PE 	Voltage Limit Type 	
		Compound Type 	
	L-N/N-PE 	*	*
		Compound Type 	
	L-PE/N-PE 	Voltage Limit Type 	
		Compound Type 	

4. Design type and protective mode of different surge protectors

Model	Uoc (1.2/50 μs) (kV)	Uc (V~)	Corresponding design type and protection mode					
NU6-III	2	275	Compound type (with gas discharge tube + voltage sensitive resistance)	Voltage limit type (with voltage sensitive resistance)	Compound type (with gas discharge tube + voltage sensitive resistance)	Voltage limit type (with voltage sensitive resistance)		
		320						
	385	L-PE/N-PE					L/N-PE	
	275							
	3	320					L-PE/N-PE	L/N-PE
		385						
	4	275	L-PE/N-PE	L/N-PE				
		320						
	6	385	L-PE/N-PE	L/N-PE				
		275						
	10	320	L-PE/N-PE	L/N-PE				
		385						
275								
320								
20	275	L-PE/N-PE	L/N-PE					
	320							

5. Functions

- 5.1 The product is composed of two independent components: removable protective module 4 and base 2;
- 5.2 When the product is damaged, the part 3 will indicate; please replace the removable protective module 4 at once and there is no need to cutoff the circuits;
- 5.3 The part 1 is for maximum continuous operational voltage indication as well as avoiding replacement with wrong module.

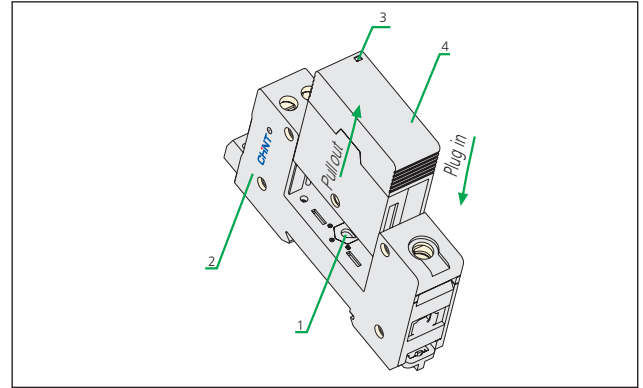

6. Overall and mounting dimensions (mm)

NU6-III/F with remote control port

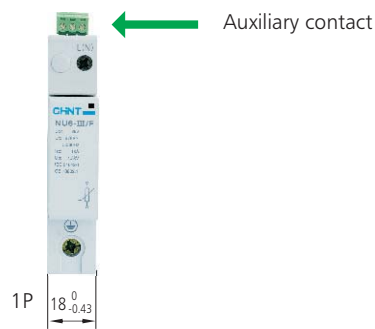
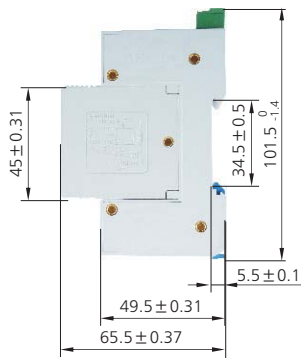

NU6-III without remote control port

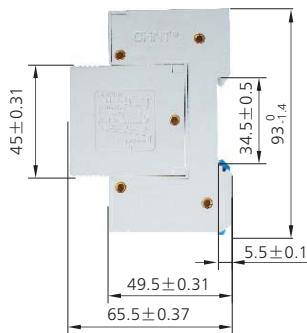

7. Ordering information

★NU6-III Compound type (L/N-PE)

Uoc (kV)	Max. continuous operational voltage U _c (V~)	With remote control port	CTN	Order code	
				Standard	RoHS
2	275	No	144	152301	-
2	320	No	144	152302	-
2	385	No	144	152303	-
3	275	No	144	152304	-
3	320	No	144	152305	-
3	385	No	144	152306	-
4	275	No	144	152307	-
4	320	No	144	152308	-
4	385	No	144	152309	-
6	275	No	144	152310	-
6	320	No	144	152311	-

★NU6-III/F Compound type (L/N-PE)

Uoc (kV)	Max. continuous operational voltage U _c (V~)	With remote control port	CTN	Order code	
				Standard	RoHS
2	275	Yes	144	152313	-
2	320	Yes	144	152314	-
2	385	Yes	144	152315	-
3	275	Yes	144	152316	-
3	320	Yes	144	152317	-
3	385	Yes	144	152318	-
4	275	Yes	144	152319	-
4	320	Yes	144	152320	-
4	385	Yes	144	152321	-
6	275	Yes	144	152322	-
6	320	Yes	144	152323	-

★NU6-III Compound type (L-N/N-PE)

Uoc (kV)	Max. continuous operational voltage U _c (V~)	With remote control port	CTN	Order code	
				Standard	RoHS
6	385	No	144	152325	-
10	275	No	144	152326	-
10	320	No	144	152327	-
10	385	No	144	152328	-
20	275	No	144	152329	-
20	320	No	144	152330	-

★NU6-III/F Compound type (L-N/N-PE)

Uoc (kV)	Max. continuous operational voltage U _c (V~)	With remote control port	CTN	Order code	
				Standard	RoHS
6	385	Yes	144	152331	-
10	275	Yes	144	152332	-
10	320	Yes	144	152333	-
10	385	Yes	144	152334	-
20	275	Yes	144	152335	-
20	320	Yes	144	152336	-

★ NU6-III Compound type (L-PE/N-PE)

Uoc (kV)	Max. continuous operational voltage U _c (V~)	With remote control port	CTN	Order code	
				Standard	RoHS
2	275	No	144	152337	-
2	320	No	144	152338	-
2	385	No	144	152339	-
3	275	No	144	152340	-
3	320	No	144	152341	-
3	385	No	144	152342	-
4	275	No	144	152343	-
4	320	No	144	152344	-
4	385	No	144	152345	-
6	275	No	144	152346	-
6	320	No	144	152347	-

★ NU6-III/F Compound type (L-PE/N-PE)

Uoc (kV)	Max. continuous operational voltage U _c (V~)	With remote control port	CTN	Order code	
				Standard	RoHS
2	275	Yes	144	152349	-
2	320	Yes	144	152350	-
2	385	Yes	144	152351	-
3	275	Yes	144	152352	-
3	320	Yes	144	152353	-
3	385	Yes	144	152354	-
4	275	Yes	144	152355	-
4	320	Yes	144	152356	-
4	385	Yes	144	152357	-
6	275	Yes	144	152358	-
6	320	Yes	144	152359	-

★NU6-III Voltage limit type (L/N-PE)

Uoc (kV)	Max. continuous operational voltage U _c (V~)	With remote control port	CTN	Order code	
				Standard	RoHS
2	275	No	144	152361	-
2	320	No	144	152362	-
2	385	No	144	152363	-
3	275	No	144	152364	-
3	320	No	144	152365	-
3	385	No	144	152366	-
4	275	No	144	152367	-
4	320	No	144	152368	-
4	385	No	144	152369	-
6	275	No	144	152370	-
6	320	No	144	152371	-
6	385	No	144	152372	-
10	275	No	144	152373	-
10	320	No	144	152374	-
10	385	No	144	152375	-
20	275	No	144	152376	-
20	320	No	144	152377	-

★NU6-III/F Voltage limit type (L/N-PE)

Uoc (kV)	Max. continuous operational voltage U _c (V~)	With remote control port	CTN	Order code	
				Standard	RoHS
2	275	Yes	144	152378	-
2	320	Yes	144	152379	-
2	385	Yes	144	152380	-
3	275	Yes	144	152381	-
3	320	Yes	144	152382	-
3	385	Yes	144	152383	-
4	275	Yes	144	152384	-
4	320	Yes	144	152385	-
4	385	Yes	144	152386	-
6	275	Yes	144	152387	-
6	320	Yes	144	152388	-
6	385	Yes	144	152389	-
10	275	Yes	144	152390	-
10	320	Yes	144	152391	-
10	385	Yes	144	152392	-
20	275	Yes	144	152393	-
20	320	Yes	144	152394	-

★NU6-III Voltage limit type (L-PE/N-PE)

Uoc (kV)	Max. continuous operational voltage U _c (V~)	With remote control port	CTN	Order code	
				Standard	RoHS
2	275	No	144	152395	-
2	320	No	144	152396	-
2	385	No	144	152397	-
3	275	No	144	152398	-
3	320	No	144	152399	-
3	385	No	144	152400	-
4	275	No	144	152401	-
4	320	No	144	152402	-
4	385	No	144	152403	-
6	275	No	144	152404	-
6	320	No	144	152405	-
6	385	No	144	152406	-
10	275	No	144	152407	-
10	320	No	144	152408	-
10	385	No	144	152409	-
20	275	No	144	152410	-
20	320	No	144	152411	-

★NU6-III/F Voltage limit type (L-PE/N-PE)

Uoc (kV)	Max. continuous operational voltage U _c (V~)	With remote control port	CTN	Order code	
				Standard	RoHS
2	275	Yes	144	152412	-
2	320	Yes	144	152413	-
2	385	Yes	144	152414	-
3	275	Yes	144	152415	-
3	320	Yes	144	152416	-
3	385	Yes	144	152417	-
4	275	Yes	144	152418	-
4	320	Yes	144	152419	-
4	385	Yes	144	152420	-
6	275	Yes	144	152421	-
6	320	Yes	144	152422	-
6	385	Yes	144	152423	-
10	275	Yes	144	152424	-
10	320	Yes	144	152425	-
10	385	Yes	144	152426	-
20	275	Yes	144	152427	-
20	320	Yes	144	152428	-

NU6- I series surge arrester	NU6- II series surge arrester	NU6-III series surge arrester
The boundary between lightning protection areas of LPZ0 & LPZ1	The boundary between lightning protection areas of LPZ1 & LPZ2	The boundary between lightning protection areas of LPZ2 & LPZ3
Protection category: B	Protection category: C	Protection category: D
Over-voltage mounting category: III	Over-voltage mounting category: II	Over-voltage mounting category: I
Rated impulse withstand voltage: 4000V	Rated impulse withstand voltage: 2500V	Rated impulse withstand voltage: 1500V
Parameters of discharge: Iimp and In	Parameters of discharge: I _{max} and I _n	Parameters of discharge: U _{oc} and I _{sc}
Applicable to master power distribution switchgear	Applicable to branch power distribution switchgear	Applicable to terminal of power distribution



*Note: Fuse/Circuit breaker are strongly recommended to be installed upstream the surge protector.

8. Recommended circuit breaker selection

Surge protector	Nominal discharge current (kA)	Circuit breaker (upstream)
NU6- I	ALL	NM8 100A
	5	NB1 C10
NU6- II	15	NB1 C20
	25	NB1 C40
	40	DZ158 C63
NU6-III	ALL	NB1 C10

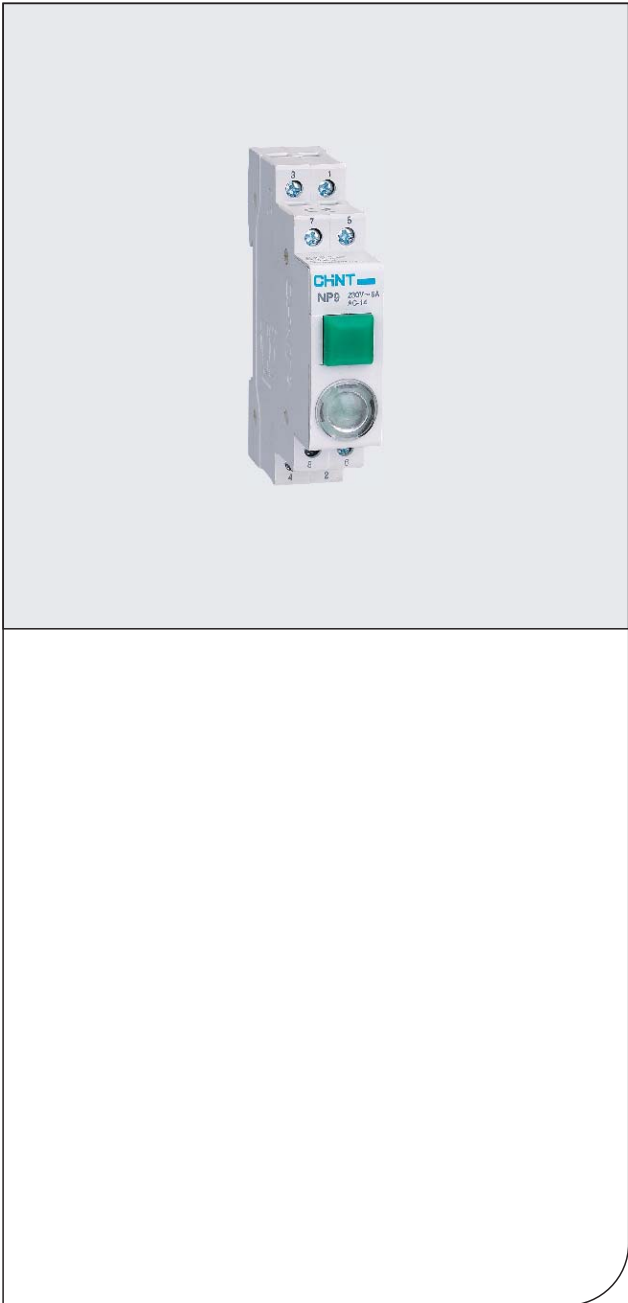

NP9 Pushbutton

1. General

- 1.1 Electric ratings: 230V, AC50/60Hz;
- 1.2 Utilization category: AC-14;
- 1.3 Rated conventional heating current I_{th}: 16A;
- 1.4 Rated operational current I_e: 6A;
- 1.5 Rated insulation voltage U_i: 500V;
- 1.6 Protection grade: IP20;
- 1.7 Standard: IEC/EN 60947-5-1;

2. Normal operational and mounting conditions

- 2.1 Ambient temperature: -5°C~+40°C,
average temperature in 24 hours not exceed +35°C;
- 2.2 Altitude: ≤ 2000m;
- 2.3 Air conditions:
At mounting site, relative humidity
not exceed 50% at the max temperature of +40°C,
higher relative humidity is allowable under lower
temperature. For example, RH could be 90% at +20°C.
Special measures should be taken to occurrence of dews;
- 2.4 Mounting category: II, III;
- 2.5 Pollution grade: II;
- 2.6 Mounting mode: TH35-7.5 standard rail,
inclination between mounting and vertical plane
not exceed 5° .

3. Technical data

- 3.1 Life (operations):
 - a. Electric life : 100,000
 - b. Mechanical life : 250,000
- 3.3 Assembly of contact: 1NC+2NO, 2NC+1NO, 3NO,
2NC+2NO(Not available for illuminated type)
- 3.4 Technical data of signal lamp
 - a. Rated operational voltage: AC/DC6.3V, AC/DC12V,
AC/DC24V, AC/DC110V, AC/DC230V
 - b. Rated operational current: ≤20mA
- 3.5 Life: LED≥30000h

4. Overall and mounting dimensions (mm)

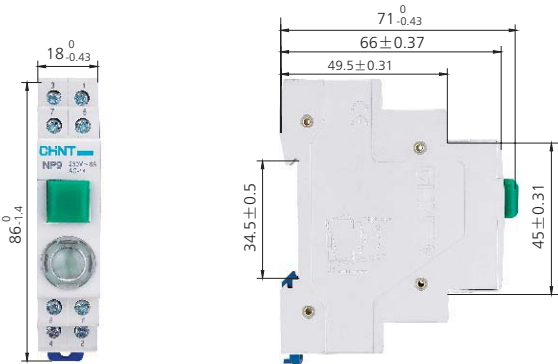

★ Illuminated type pushbutton

Operational voltage (V)	Current (A)	Indicator light type	Number of contact	Color	CTN	Order code	
						Standard	RoHS
AC230	≤6	LED/230V	3NO, 0NC	Red	192	153020	-
AC230	≤6	LED/230V	2NO, 1NC	Red	192	153021	-
AC230	≤6	LED/230V	1NO, 2NC	Red	192	153022	-
AC230	≤6	LED/230V	3NO, 0NC	Green	192	153023	-
AC230	≤6	LED/230V	2NO, 1NC	Green	192	153024	-
AC230	≤6	LED/230V	1NO, 2NC	Green	192	153025	-
AC230	≤6	LED/110V	3NO, 0NC	Red	192	153026	-
AC230	≤6	LED/110V	2NO, 1NC	Red	192	153027	-
AC230	≤6	LED/110V	1NO, 2NC	Red	192	153028	-
AC230	≤6	LED/110V	3NO, 0NC	Green	192	153029	-
AC230	≤6	LED/110V	2NO, 1NC	Green	192	153030	-
AC230	≤6	LED/110V	1NO, 2NC	Green	192	153031	-
AC230	≤6	LED/24V	3NO, 0NC	Red	192	153032	-
AC230	≤6	LED/24V	2NO, 1NC	Red	192	153033	-
AC230	≤6	LED/24V	1NO, 2NC	Red	192	153034	-
AC230	≤6	LED/24V	3NO, 0NC	Green	192	153035	-
AC230	≤6	LED/24V	2NO, 1NC	Green	192	153036	-
AC230	≤6	LED/24V	1NO, 2NC	Green	192	153037	-
AC230	≤6	LED/12V	3NO, 0NC	Red	192	153038	-
AC230	≤6	LED/12V	2NO, 1NC	Red	192	153039	-
AC230	≤6	LED/12V	1NO, 2NC	Red	192	153040	-
AC230	≤6	LED/12V	3NO, 0NC	Green	192	153041	-
AC230	≤6	LED/12V	2NO, 1NC	Green	192	153042	-
AC230	≤6	LED/12V	1NO, 2NC	Green	192	153043	-
AC230	≤6	LED/6.3V	3NO, 0NC	Red	192	153044	-
AC230	≤6	LED/6.3V	2NO, 1NC	Red	192	153045	-
AC230	≤6	LED/6.3V	1NO, 2NC	Red	192	153046	-
AC230	≤6	LED/6.3V	3NO, 0NC	Green	192	153047	-
AC230	≤6	LED/6.3V	2NO, 1NC	Green	192	153048	-
AC230	≤6	LED/6.3V	1NO, 2NC	Green	192	153049	-

★ Non-illuminated type

Operational voltage (V)	Current (A)	Indicator light type	Number of contact	Color	CTN	Order code	
						Standard	RoHS
AC230	≤6	-	3NO, 0NC	Red	192	153050	-
AC230	≤6	-	2NO, 1NC	Red	192	153051	-
AC230	≤6	-	1NO, 2NC	Red	192	153052	-
AC230	≤6	-	2NO, 2NC	Red	192	153053	-
AC230	≤6	-	3NO, 0NC	Green	192	153054	-
AC230	≤6	-	2NO, 1NC	Green	192	153055	-
AC230	≤6	-	1NO, 2NC	Green	192	153056	-
AC230	≤6	-	2NO, 2NC	Green	192	153057	-



ND9 Indicator Light

1. General

- 1.1 Electric ratings: 230V, AC50/60Hz;
- 1.2 Rated insulation voltage U_i : 500V;
- 1.3 Protection grade: IP20
- 1.4 Rated operational current: $\leq 20\text{mA}$
- 1.5 Life: LED $\geq 30000\text{h}$;
- 1.6 Standard: IEC/EN 60947-5-1

2. Normal operational and mounting conditions

- 2.1 Ambient temperature: $-5^\circ\text{C} \sim +40^\circ\text{C}$,
average temperature in 24 hours not exceed $+35^\circ\text{C}$;
- 2.2 Altitude: $\leq 2000\text{m}$;
- 2.3 Air conditions:
At mounting site, relative humidity not exceed 50% at the max temperature of $+40^\circ\text{C}$, higher relative humidity is allowable under lower temperature. For example, RH could be 90% at $+20^\circ\text{C}$. Special measures should be taken to occurrence of dew;
- 2.4 Mounting category: II, III;
- 2.5 Pollution grade: II;
- 2.6 Mounting mode: TH35-7.5 standard rail, inclination between mounting and vertical plane not exceed 5°

3. Ordering information

★ Single lamp indicator light

Operational voltage (V)	Current (mA)	Indicator light type	Color	CTN	Order code	
					Standard	RoHS
6.3 AC/DC	≤ 20	LED	Green	192	153101	-
12 AC/DC	≤ 20	LED	Green	192	153102	-
24 AC/DC	≤ 20	LED	Green	192	153103	-
110 AC/DC	≤ 20	LED	Green	192	153104	-
230 AC/DC	≤ 20	LED	Green	192	153105	-
6.3 AC/DC	≤ 20	LED	Red	192	153106	-
12 AC/DC	≤ 20	LED	Red	192	153107	-
24 AC/DC	≤ 20	LED	Red	192	153108	-
110 AC/DC	≤ 20	LED	Red	192	153109	-
230 AC/DC	≤ 20	LED	Red	192	153110	-
6.3 AC/DC	≤ 20	LED	Yellow	192	153111	-
12 AC/DC	≤ 20	LED	Yellow	192	153112	-
24 AC/DC	≤ 20	LED	Yellow	192	153113	-
110 AC/DC	≤ 20	LED	Yellow	192	153114	-
230 AC/DC	≤ 20	LED	Yellow	192	153115	-
6.3 AC/DC	≤ 20	LED	Blue	192	153116	-
12 AC/DC	≤ 20	LED	Blue	192	153117	-
24 AC/DC	≤ 20	LED	Blue	192	153118	-
110 AC/DC	≤ 20	LED	Blue	192	153119	-
230 AC/DC	≤ 20	LED	Blue	192	153120	-
6.3 AC/DC	≤ 20	LED	White	192	153121	-
12 AC/DC	≤ 20	LED	White	192	153122	-
24 AC/DC	≤ 20	LED	White	192	153123	-
110 AC/DC	≤ 20	LED	White	192	153124	-
230 AC/DC	≤ 20	LED	White	192	153125	-

★ Dual-lamps indicator light

Operational voltage (V)	Current (mA)	Indicator light type	Color	CTN	Order code	
					Standard	RoHS
6.3 AC/DC	≤20	LED	Green+Green	192	153126	-
12 AC/DC	≤20	LED	Green+Green	192	153127	-
24 AC/DC	≤20	LED	Green+Green	192	153128	-
110 AC/DC	≤20	LED	Green+Green	192	153129	-
230 AC/DC	≤20	LED	Green+Green	192	153130	-
6.3 AC/DC	≤20	LED	Green+Red	192	153131	-
12 AC/DC	≤20	LED	Green+Red	192	153132	-
24 AC/DC	≤20	LED	Green+Red	192	153133	-
110 AC/DC	≤20	LED	Green+Red	192	153134	-
230 AC/DC	≤20	LED	Green+Red	192	153135	-
6.3 AC/DC	≤20	LED	Green+Yellow	192	153136	-
12 AC/DC	≤20	LED	Green+Yellow	192	153137	-
24 AC/DC	≤20	LED	Green+Yellow	192	153138	-
110 AC/DC	≤20	LED	Green+Yellow	192	153139	-
230 AC/DC	≤20	LED	Green+Yellow	192	153140	-
6.3 AC/DC	≤20	LED	Green+Blue	192	153141	-
12 AC/DC	≤20	LED	Green+Blue	192	153142	-
24 AC/DC	≤20	LED	Green+Blue	192	153143	-
110 AC/DC	≤20	LED	Green+Blue	192	153144	-
230 AC/DC	≤20	LED	Green+Blue	192	153145	-
6.3 AC/DC	≤20	LED	Green+White	192	153146	-
12 AC/DC	≤20	LED	Green+White	192	153147	-
24 AC/DC	≤20	LED	Green+White	192	153148	-
110 AC/DC	≤20	LED	Green+White	192	153149	-
230 AC/DC	≤20	LED	Green+White	192	153150	-
6.3 AC/DC	≤20	LED	Red+Red	192	153151	-
12 AC/DC	≤20	LED	Red+Red	192	153152	-
24 AC/DC	≤20	LED	Red+Red	192	153153	-
110 AC/DC	≤20	LED	Red+Red	192	153154	-
230 AC/DC	≤20	LED	Red+Red	192	153155	-
6.3 AC/DC	≤20	LED	Red+Yellow	192	153156	-
12 AC/DC	≤20	LED	Red+Yellow	192	153157	-
24 AC/DC	≤20	LED	Red+Yellow	192	153158	-
110 AC/DC	≤20	LED	Red+Yellow	192	153159	-
230 AC/DC	≤20	LED	Red+Yellow	192	153160	-
6.3 AC/DC	≤20	LED	Red+Blue	192	153161	-
12 AC/DC	≤20	LED	Red+Blue	192	153162	-
24 AC/DC	≤20	LED	Red+Blue	192	153163	-
110 AC/DC	≤20	LED	Red+Blue	192	153164	-
230 AC/DC	≤20	LED	Red+Blue	192	153165	-
6.3 AC/DC	≤20	LED	Red+White	192	153166	-
12 AC/DC	≤20	LED	Red+White	192	153167	-
24 AC/DC	≤20	LED	Red+White	192	153168	-
110 AC/DC	≤20	LED	Red+White	192	153169	-
230 AC/DC	≤20	LED	Red+White	192	153170	-

Operational voltage (V)	Current (mA)	Indicator light type	Color	CTN	Order code	
					Standard	RoHS
6.3 AC/DC	≤20	LED	Yellow+Yellow	192	153171	-
12 AC/DC	≤20	LED	Yellow+Yellow	192	153172	-
24 AC/DC	≤20	LED	Yellow+Yellow	192	153173	-
110 AC/DC	≤20	LED	Yellow+Yellow	192	153174	-
230 AC/DC	≤20	LED	Yellow+Yellow	192	153175	-
6.3 AC/DC	≤20	LED	Yellow+Blue	192	153176	-
12 AC/DC	≤20	LED	Yellow+Blue	192	153177	-
24 AC/DC	≤20	LED	Yellow+Blue	192	153178	-
110 AC/DC	≤20	LED	Yellow+Blue	192	153179	-
230 AC/DC	≤20	LED	Yellow+Blue	192	153180	-
6.3 AC/DC	≤20	LED	Yellow+White	192	153181	-
12 AC/DC	≤20	LED	Yellow+White	192	153182	-
24 AC/DC	≤20	LED	Yellow+White	192	153183	-
110 AC/DC	≤20	LED	Yellow+White	192	153184	-
230 AC/DC	≤20	LED	Yellow+White	192	153185	-
6.3 AC/DC	≤20	LED	Blue+Blue	192	153186	-
12 AC/DC	≤20	LED	Blue+Blue	192	153187	-
24 AC/DC	≤20	LED	Blue+Blue	192	153188	-
110 AC/DC	≤20	LED	Blue+Blue	192	153189	-
230 AC/DC	≤20	LED	Blue+Blue	192	153190	-
6.3 AC/DC	≤20	LED	Blue+White	192	153191	-
12 AC/DC	≤20	LED	Blue+White	192	153192	-
24 AC/DC	≤20	LED	Blue+White	192	153193	-
110 AC/DC	≤20	LED	Blue+White	192	153194	-
230 AC/DC	≤20	LED	Blue+White	192	153195	-
6.3 AC/DC	≤20	LED	White+White	192	153196	-
12 AC/DC	≤20	LED	White+White	192	153197	-
24 AC/DC	≤20	LED	White+White	192	153198	-
110 AC/DC	≤20	LED	White+White	192	153199	-
230 AC/DC	≤20	LED	White+White	192	153200	-

4. Wirng

Cross section area of the conductor is 1.0mm², and tightening torque should be 0.8N·m

5. Overall and mounting dimensions (mm)

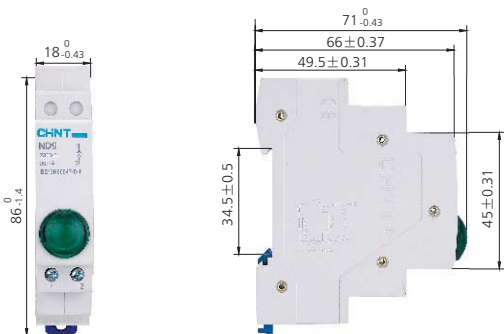



NX8 Consumer Unit (Body)

1. General

- 1.1 Electric ratings: up to 100A, 230V, AC50/60Hz;
- 1.2 No. Of mounted units: 5, 8, 12, 15, 20, 24;
- 1.3 On-load current (A): 100/1-phase;
- 1.4 Allowable temperature-rise of frame (k): 40;
- 1.5 Protection degree: IP30;
- 1.6 Standard: IEC/EN 60439-3 (IEC/EN 60670-24)

2. Features

- 2.1 The window of the consumer unit is designed with novel appearance and convenient operation. Open and close operation is flexible, and self-locking at the open status;
- 2.2 Inside the product, there is a neon indicator light to indicate status of power supply; having a elegant appearance and clear indication;
- 2.3 The interiorly mounted MCBs are all in compliance with relative IEC standards, 9mm modularized electric components are applicable, as well;
- 2.4 On request, various circuit combinations can be assembled; and the mounting capacity of the product units can be taken to 5~24 units;
- 2.5 Convenient and reliable operation, having exposed handle, and all live parts to be mounted inside the wall box ;
- 2.6 The consumer unit is designed with internal terminal blocks for connection of neutral line and protective grounding wire.
- 2.7 The enclosure of the unit is made of plastic material with metal structure;
- 2.8 On request, specified colors are available.

3. Overall and mounting dimensions (mm)

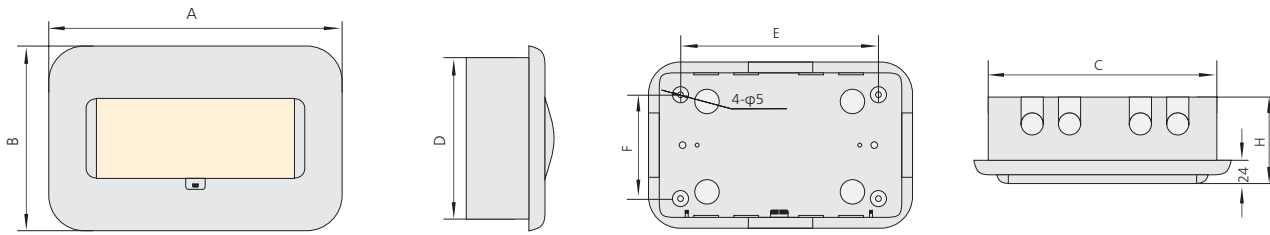

Model	A	B	C	D	E	F	H	Remark
NX8-5	184±1.45	200±1.45	164±1.25	180±1.45	114±1.1	130±1.25	105 ⁰ _{-2.2}	Single-row
NX8-5J	184±1.45	200±1.45	164±1.25	180±1.45	114±1.1	130±1.25	105 ⁰ _{-2.2}	Single-row
NX8-8	238±1.45	200±1.45	218±1.45	180±1.45	168±1.25	130±1.25	105 ⁰ _{-2.2}	Single-row
NX8-8J	238±1.45	200±1.45	218±1.45	180±1.45	168±1.25	130±1.25	105 ⁰ _{-2.2}	Single-row
NX8-12	310±1.6	200±1.45	290±1.6	180±1.45	240±1.45	130±1.25	105 ⁰ _{-2.2}	Single-row
NX8-12J	310±1.6	200±1.45	290±1.6	180±1.45	240±1.45	130±1.25	105 ⁰ _{-2.2}	Single-row
NX8-15	364±1.8	200±1.45	344±1.8	180±1.45	294±1.6	130±1.25	105 ⁰ _{-2.2}	Single-row
NX8-15J	364±1.8	200±1.45	344±1.8	180±1.45	294±1.6	130±1.25	105 ⁰ _{-2.2}	Single-row
NX8-20	274±1.6	350±1.8	254±1.6	330±1.8	204±1.45	280±1.6	105 ⁰ _{-2.2}	Double-rows
NX8-20J	274±1.6	350±1.8	254±1.6	330±1.8	204±1.45	280±1.6	105 ⁰ _{-2.2}	Double-rows
NX8-24	310±1.6	350±1.8	290±1.6	330±1.8	204±1.45	280±1.6	105 ⁰ _{-2.2}	Double-rows
NX8-24J	310±1.6	350±1.8	290±1.6	330±1.8	204±1.45	280±1.6	105 ⁰ _{-2.2}	Double-rows

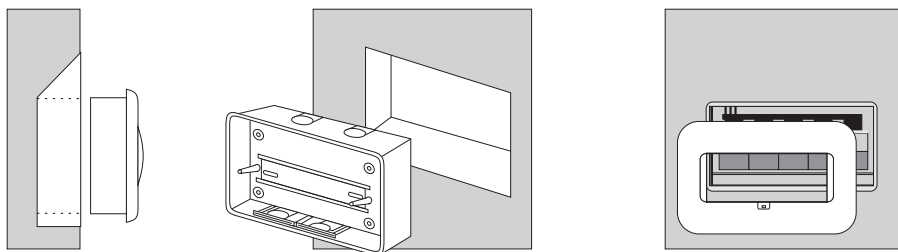

4. Ordering information

Model	Number of circuits	Iron base	Order code	
			Standard	RoHS
NX8	5	No	151101	971259
NX8	5	Yes	151102	971260
NX8	8	No	151103	971261
NX8	8	Yes	151104	971262
NX8	12	No	151105	971263
NX8	12	Yes	151106	971264
NX8	15	No	151107	971265
NX8	15	Yes	151108	971266
NX8	20	No	151109	971267
NX8	20	Yes	151110	971268
NX8	24	No	151111	971269
NX8	24	Yes	151112	971270



NX2 Consumer Unit (Body)

1. General

- 1.1 Electric ratings: up to 100A, 230V, AC50/60Hz;
- 1.2 No. Of mounted units: 8, 10, 14, 18, 28, 36;
- 1.3 On-load current (A): 100/1-phase;
- 1.4 Allowable temperature-rise of enclosure: 40k;
- 1.5 Protection degree: IP2XC;
- 1.6 Standard: IEC/EN 60439-3 (IEC/EN 60670-24)

2. Features

- 2.1 The product has appearance patent. In addition to the standard mounting rail, a front panel for fixing is supplied. The shape fixing bolts are easy for fastening and loosening.
- 2.2 The interiorly mounted MCBs are in compliance with relative IEC standards, 9mm modularized electric components are available, as well.
- 2.3 On request, various circuits combinations can be assembled; and the mounting capacity of the product units can be taken to 8~36 units.
- 2.4 Convenient and reliable operation, having exposed handle, and all live parts to be mounted inside the wall box.
- 2.5 The consumer unit is designed with internal terminal blocks for connection of neutral line and protective grounding wire.
- 2.6 The enclosure of the unit is made of plastic material.

3. Overall and mounting dimensions (mm)

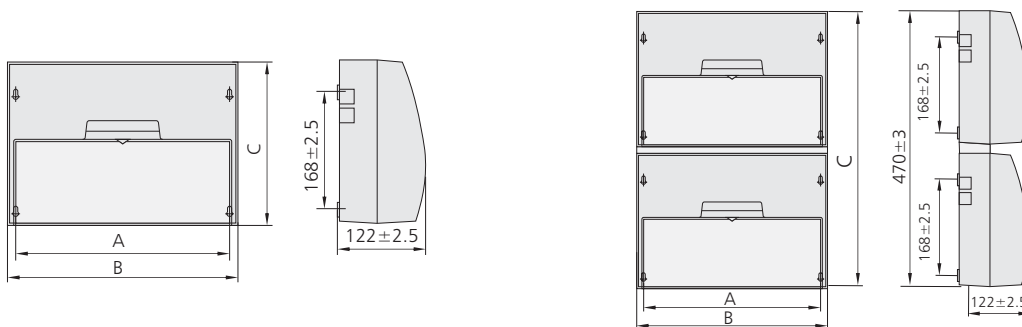

Model	A	B	C	Remark
NX2-8	194±2.5	218±2.5	230±2.5	Single-row
NX2-10	232±2.5	256±2.5	230±2.5	
NX2-14	302±2.5	326±2.5	230±2.5	
NX2-18	374±2.5	398±2.5	230±2.5	
NX2-28	302±2.5	326±2.5	470±3	Double-rows
NX2-36	374±2.5	398±2.5	470±3	

Model	Number of circuits	Order code	
		Standard	RoHS
NX2	8	*	982309
NX2	10	151001	971256
NX2	14	151002	971257
NX2	18	151003	971258
NX2	24	*	985553
NX2	28	*	985554



NXW1 Consumer Unit (NXW1 Consumer Unit Body) for Outdoor Application

1. General

- 1.1 Electric ratings: up to 63A, 230V, AC50/60Hz;
- 1.2 No. of mounted units: 3, 5;
- 1.3 On-load current A: 63;
- 1.4 Allowable temperature-rise of enclosure: 40k;
- 1.5 Protection degree: IP65;
- 1.6 Standard: IEC/EN 60439-3 (IEC/EN 60670-24)

2. Features

- 2.1 Special designed with excellent enclosure capability; with high protection degree up to IP65, applicable for outdoor mounting.
- 2.2 The interiorly mounted MCBs are all in compliance with relative IEC standards, 9mm modularized electric components are applicable, as well;
- 2.3 On request, various circuit combinations can be assembled; and the mounting capacity of the product units can be taken to 3~ 5units;
- 2.4 Convenient and reliable operation, having exposed handle, and all live parts to be mounted inside the wall box;
- 2.5 The consumer unit is designed with internal terminal blocks for connection of neutral line and protective grounding wire.
- 2.6 The enclosure of the unit is made of plastic material.

3. Overall and mounting dimensions (mm)

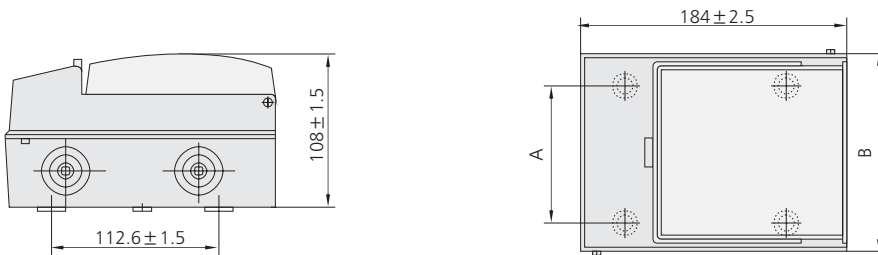

Model	A	B
NXW1-3	66.8 ± 1.5	100 ± 1.5
NXW1-5	102.8 ± 1.5	136 ± 2.5

4. Ordering information

Model	Number of circuits	Order code	
		Standard	RoHS
NXW1	3	151201	971271
NXW1	5	151202	971272

NXW5 Wall Mounting Enclosure



- ① ---- Door lock: The operated lock for preventing unwanted operation.
- ② ---- Panel: Zinc-plated steel panel
- ③ ---- Earthing studs: Earthing connection between body and door.
- ④ ---- Wall fixing brackets: For easy surface installation.
- ⑤ ---- Hinges: Hinged connection provide better operating.
- ⑥ ---- Flanged panel: With sealing gasket that increased cable entry capacity.
- ⑦ ---- Sealing rubber gasket: Make high protection degree.
- ⑧ ---- Studs: For additional panel.

NXW5 Wall Mounting Enclosure



1. General

1.1 Function

The Wall Mounting Enclosure is designed to adopt all kind of Electrical switch gear & control gear assemblies. It is suitable for variety of Electrical installations in commercial & light industrial premises. It is designed for indoor & outdoor applications.

1.2 Features

Made out of high quality Electro galvanized steel up to 1.6mm thickness.

Removable Gland plate at the Bottom.

Canopies can be fixed as optional.

Also double insulation; excellent out door performance.

Mounting plate made of 2mm GI steel or RAL 2000

Orange powder coated.

Complies with IEC & NEMA standards.

Available in Double door construction for width more than 800mm.

Corner formed covers ensures better rain proof protection & aesthetic look

3 point cam lock for higher sizes ensures uniform locking over the entire length.

2. Technical data

Standard	IEC 62208
Rated voltage	230V/400V
Frequency	50/60Hz
Max. incoming current(three phases)	250A
Protection degree	IP54/IP65(optional)
Allowable temperature-rise of enclosure	70K

3. Terminals max. cable size

Incoming terminals	2 × 185 mm ²
--------------------	-------------------------

4. Overall and mounting dimensions (mm)

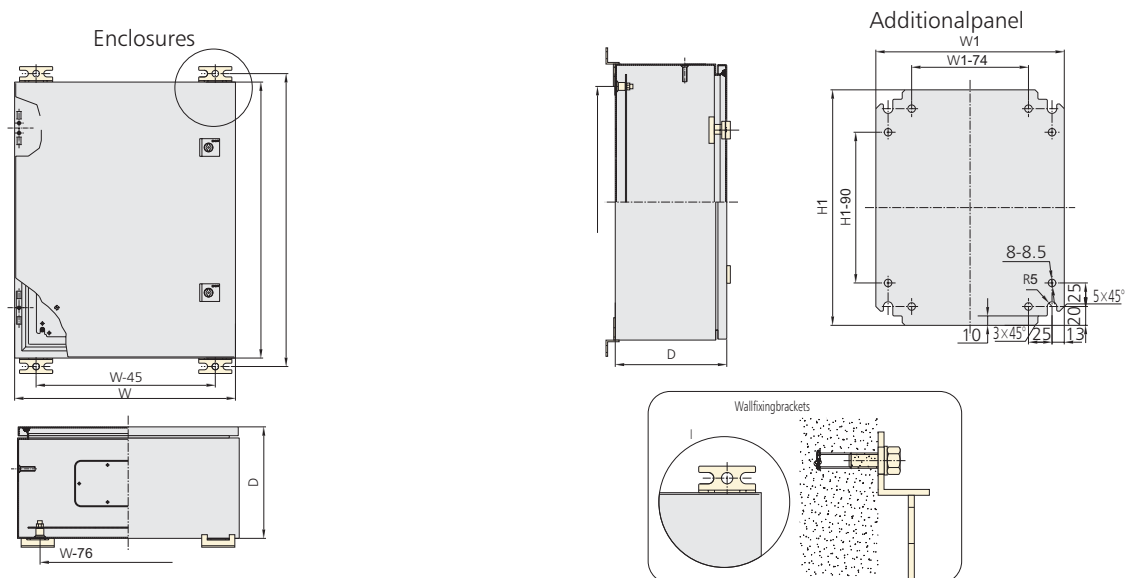

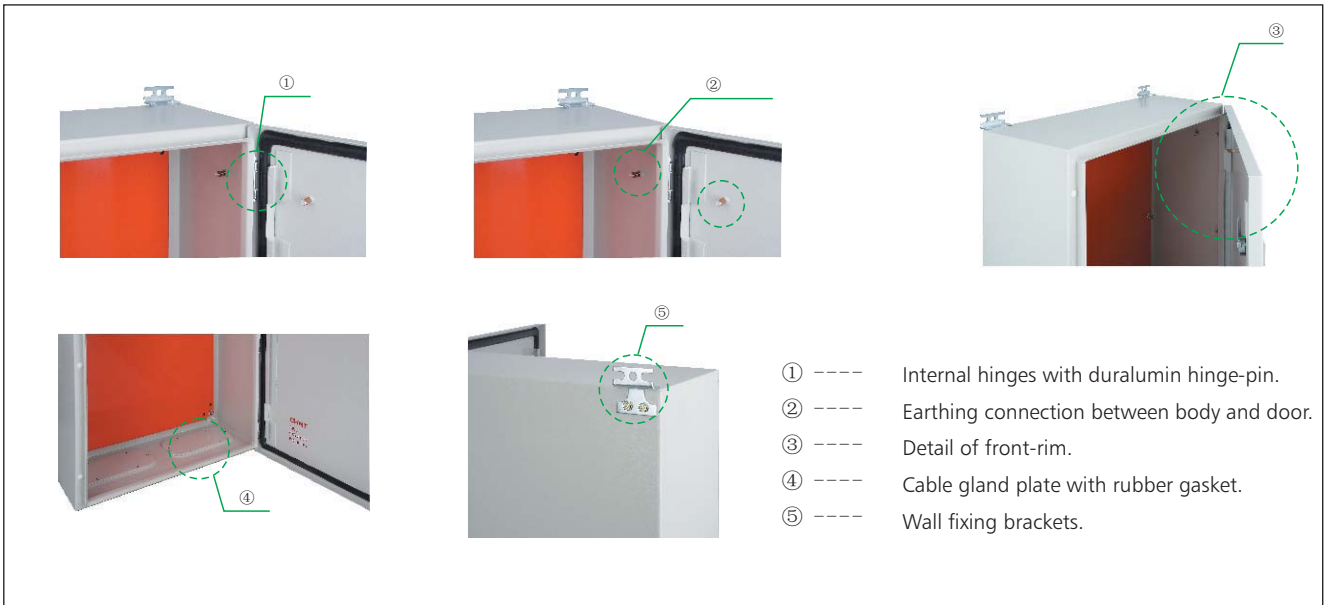

Flange openings

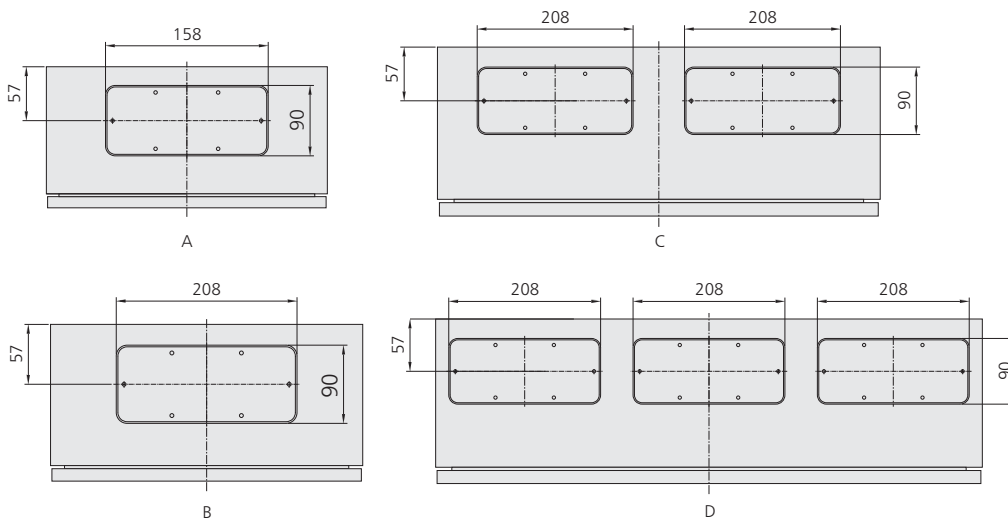

Note: The thickness of installation panel could be changed according to your specific requirement. (Max. thickness 2.0mm). Drawing-bar lock is available when the width of JXF is bigger than 800mm.

5. Ordering information

Model No.	Height(H)×Width(W)× Depth(D)	No. of locks	No. of hinges	Flange openings	Thickness
NXW5-2520/15	250×200×150	1	2	A	1.2
NXW5-3025/15	300×250×150	1	2	A	1.2
NXW5-3025/20	300×250×200	1	2	A	1.2
NXW5-3030/15	300×300×150	1	2	A	1.2
NXW5-3030/20	300×300×200	1	2	A	1.2
NXW5-3040/15	300×400×150	1	2	B	1.2
NXW5-3040/20	300×400×200	1	2	B	1.2

Model No.	Height(H)×Width(W)× Depth(D)	No. of locks	No. of hinges	Flange openings	Thickness
NXW5-4030/15	400×300×150	1	2	A	1.2
NXW5-4030/20	400×300×200	1	2	A	1.2
NXW5-4040/15	400×400×150	1	2	B	1.2
NXW5-4040/20	400×400×200	1	2	B	1.2
NXW5-4060/15	400×600×150	1	2	C	1.2
NXW5-4060/20	400×600×200	1	2	C	1.2
NXW5-4060/25	400×600×250	1	2	C	1.2
NXW5-5040/15	500×400×150	2	2	B	1.2
NXW5-5040/20	500×400×200	2	2	B	1.2
NXW5-5040/25	500×400×250	2	2	B	1.2
NXW5-5050/15	500×500×150	2	2	B	1.2
NXW5-5050/20	500×500×200	2	2	B	1.2
NXW5-5050/25	500×500×250	2	2	B	1.2
NXW5-6040/15	600×400×150	2	2	B	1.2
NXW5-6040/20	600×400×200	2	2	B	1.2
NXW5-6040/25	600×400×250	2	2	B	1.2
NXW5-6050/15	600×500×150	2	2	B	1.2
NXW5-6050/20	600×500×200	2	2	B	1.2
NXW5-6050/25	600×500×250	2	2	B	1.2
NXW5-6060/20	600×600×200	2	2	C	1.2
NXW5-6060/25	600×600×250	2	2	C	1.2
NXW5-6060/30	600×600×300	2	2	C	1.2
NXW5-7050/15	700×500×150	2	2	B	1.5
NXW5-7050/20	700×500×200	2	2	B	1.5
NXW5-7050/25	700×500×250	2	2	B	1.5
NXW5-7050/30	700×500×300	2	2	B	1.5
NXW5-8060/20	800×600×200	2	3	C	1.5
NXW5-8060/25	800×600×250	2	3	C	1.5
NXW5-8060/30	800×600×300	2	3	C	1.5
NXW5-8060/38	800×600×380	2	3	C	1.5
NXW5-8080/20	800×800×200	2	3	C	1.5
NXW5-8080/25	800×800×250	2	3	C	1.5
NXW5-8080/30	800×800×300	2	3	C	1.5
NXW5-10060/25	1000×600×250	2	4	C	1.5
NXW5-10060/30	1000×600×300	2	4	C	1.5
NXW5-10060/38	1000×600×380	2	4	C	1.5
NXW5-10060/45	1000×600×450	2	4	C	1.5
NXW5-10080/25	1000×800×250	2	4	C	1.5
NXW5-10080/30	1000×800×300	2	4	C	1.5
NXW5-10080/38	1000×800×380	2	4	C	1.5
NXW5-10080/45	1000×800×450	2	4	C	1.5
NXW5-100100/25	1000×1000×250	2	4	D	1.5
NXW5-100100/30	1000×1000×300	2	4	D	1.5
NXW5-12080/25	1200×800×250	3	5	C	1.5
NXW5-12080/30	1200×800×300	3	5	C	1.5
NXW5-12080/38	1200×800×380	3	5	C	1.5
NXW5-12080/45	1200×800×450	3	5	C	1.5
NXW5-120100/25	1200×1000×250	3	5	D	1.5
NXW5-120100/30	1200×1000×300	3	5	D	1.5



MCB Shield (For eB and NH2)

1. General

Guarantee MCBs' wiring safety.

2. Features

Rated voltage: 220...240/380...415V

Rated current: up to 100A

Frequency: 50/60Hz

Poles of mounted units: 1P, 3P

3. Overall and mounting dimensions (mm)

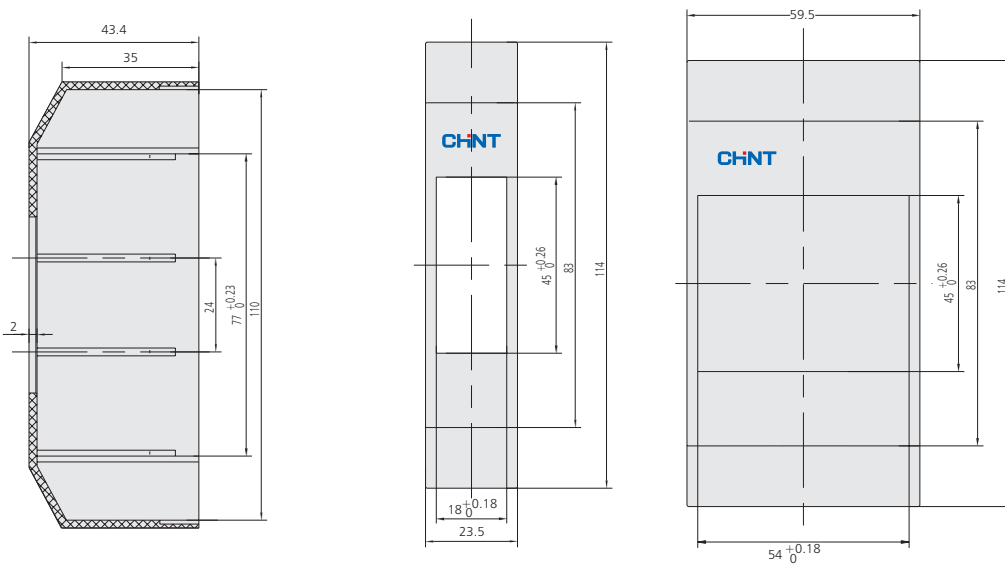

**Busbar
1. Busbar for MCB & RCCB**

Model		Number of poles	Cross section (mm ²)	Length L (m)	Order code
	Fork Type	1P	12	1	131501
	Fork Type	2P	12	1	131502
	Fork Type	3P	12	1	131503
	Fork Type	4P	12	1	131504
	Pin Type	1P	12	1	131505
	Pin Type	1P	16	1	131506
	Pin Type	2P	12	1	131507
	Pin Type	2P	16	1	131508
	Pin Type	3P	12	1	131509
	Pin Type	3P	16	1	131510
	Pin Type	4P	12	1	131511
	Pin Type	4P	16	1	131512

2. Busbar for RCBO

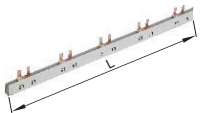
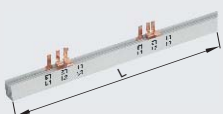
Model		Number of poles	Cross section (mm ²)	Length L (m)	Order code
	Pin Type	2P	10	1	131514
	Pin Type	3P	10	1	131515

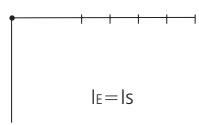
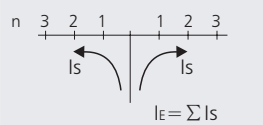
		1-phase						2, 3 and 4 phase											
Feed-in from end cross section (mm ²)	 $I_E = I_s$	10	12	16	20	25	35	10	16	25	36								
max. current (A)		63	65	80	90	100	130	63	80	100	130								
Feed-in from the middle max. current (A)	 $I_E = \sum I_s$	n	3	2	1	1	2	3	n	100	110	130	150	180	220	100	130	180	220
Max. feed-in current (A)		Depends on the cross section for connection!																	

3. DIN rail

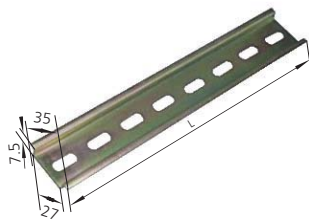

Model	L(m)	Order code
DIN rail	1	131550



NZK1-32 Change-over Switch

1. General

- 1.1 Certificates: KEMA;
- 1.2 Electric ratings: AC 50/60Hz;
rated voltage up to 250V, rated current 32A;
- 1.3 Standard: IEC60669-1

2. Operation conditions

- 2.1 Temperature: -5°C~+40°C;
the average value shall not exceed +35°C
- 2.2 Altitude: ≤2000m;
- 2.3 Air conditions:
At mounting site, relative humidity not exceed 50% at the max temperature of +40°C, higher relative humidity is allowable under lower temperature. For example, RH could be 90% at +20°C, special measures should be taken to occurrence of dews.
- 2.4 Mounting conditions:
Inclination between the mounting plane and the vertical plane should not exceed ±5°
- 2.5 Assemble with TH35-7.5 steel mounting rail

3. Type designation

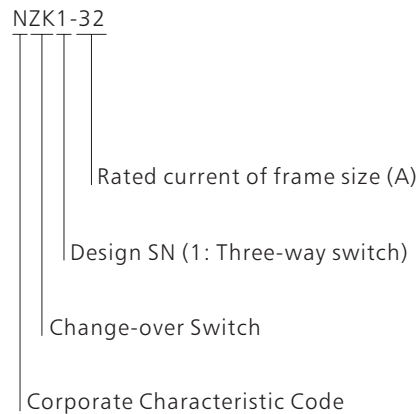

4. Technical data

- 4.1 Poles: 1P, 2P
- 4.2 Rated frequency: 50Hz/60Hz;
- 4.3 Rated operating current Ie: 32A;
- 4.4 Rated voltage Ue: 250V;
- 4.4 Rated making and breaking capacity:
1.1 Ue; 1.25Ie; COSΦ=0.3±0.05; 200 times
- 4.5 Operational performance:
Ue^{+5%}Ie; COSΦ=0.6±0.05; 10000 times

5. Circuit diagram

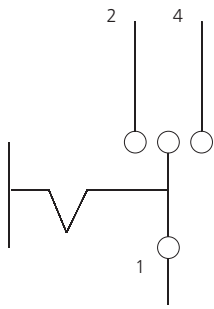

NZK1-32/1

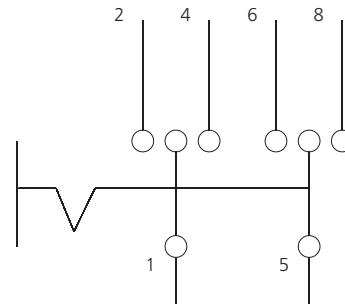

NZK1-32/2

6. Overall and mounting dimensions (mm)

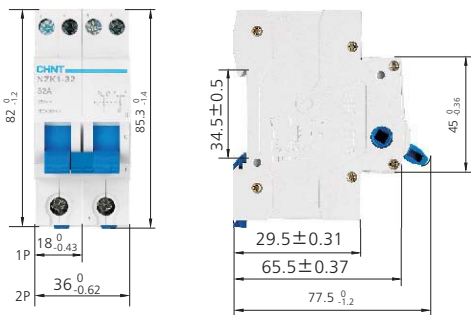

Mounting Rail Dimensions

7. Installation and usage

- 7.1 Prior to installation, check whether the switch symbol complies with the operating conditions.
- 7.2 As shown, snap into the mounting rail.
Contact 1-2 is closed when the handle is at position I, contact 1-4 is closed when the handle is at position II, and contact 1-2, 1-4 are closed when the handle is at position 0.
- 7.3 Before turning the power ON, operate the switch several times to ensure that it is flexible and reliable, without any delay.
- 7.4 The switch must be protected against rain during usage, storage and transportation, etc.

8. Order Information

- 8.1 Indicate the following order information:
 - a) Product model and name, e.g. Change-over switch NZK1-32
 - b) Number of poles, e.g. 2P
 - c) Quantity of order, e.g. 100 units
- 8.2 Example:
e.g. Change-over switch NZK1-32/2 100 units



NZK2-32 Change-over Switch

1. General

- 1.1 Certificates: KEMA;
- 1.2 Electric ratings: AC 50/60Hz;
rated voltage up to 250V, rated current 32A;
- 1.3 Standard: IEC60669-1

2. Operation conditions

- 2.1 Temperature: -5°C~+40°C;
the average value shall not exceed +35°C
- 2.2 Altitude: ≤2000m;
- 2.3 Air conditions:
At mounting site, relative humidity not exceed 50% at the max temperature of +40°C, higher relative humidity is allowable under lower temperature. For example, RH could be 90% at +20°C, special measures should be taken to occurrence of dews.
- 2.4 Mounting conditions:
Inclination between the mounting plane and the vertical plane should not exceed ±5°
- 2.5 Assemble with TH35-7.5 steel mounting rail

3. Type designation

NZK2-32

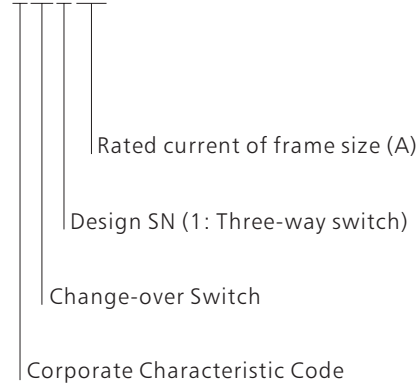

4. Technical data

- 4.1 Poles: 1P, 2P
- 4.2 Rated frequency: 50Hz/60Hz;
- 4.3 Rated operating current Ie: 32A;
- 4.4 Rated voltage Ue: 250V;
- 4.4 Rated making and breaking capacity:
1.1 Ue; 1.25Ie; COSΦ=0.3±0.05; 200 times
- 4.5 Operational performance:
Ue^{+5%}Ie; COSΦ=0.6±0.05; 10000 times

5. Circuit diagram

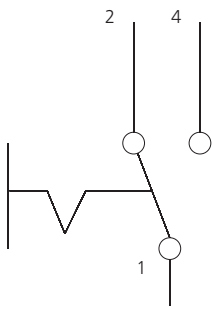

NZK2-32/1

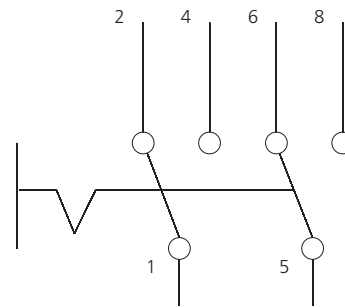

NZK2-32/2

6. Overall and mounting dimensions (mm)

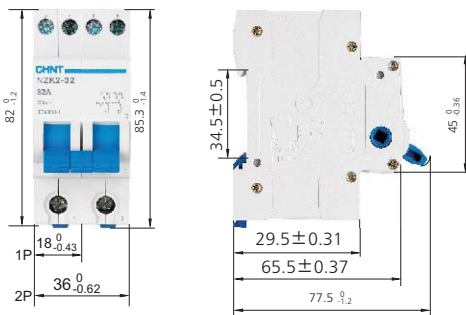

Mounting Rail Dimensions

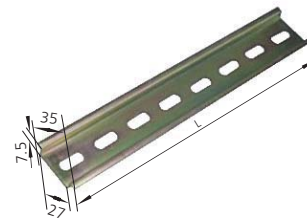

7. Installation and usage

- 7.1 Prior to installation, check whether the switch symbol complies with the operating conditions.
- 7.2 As shown, snap into the mounting rail.
Contact 1-2 is closed when the handle is at position I, contact 1-4 is closed when the handle is at position II, and contact 1-2 is broken.
- 7.3 Before turning the power ON, operate the switch several times to ensure that it is flexible and reliable, without any delay.
- 7.4 The switch must be protected against rain during usage, storage and transportation, etc.

8. Order Information

- 8.1 Indicate the following order information:
 - a) Product model and name, e.g. Change-over switch NZK2-32
 - b) Number of poles, e.g. 2P
 - c) Quantity of order, e.g. 100 units
- 8.2 Example:
e.g. Change-over switch NZK2-32/2 100 units

Model	Technical features					
	Application	Standard	Poles	Designation	Rated current	Breaking capacity
NB1	AC	IEC/EN 60898-1	1P/2P/3P/4P	B/C/D	1-63A	6000A
			1P/2P/3P		6-63A	10000A
		IEC/EN 60947-2 VC8036	1P/2P/3P/4P	8-12In	1-63A	6KA
		UL1077	1P/2P/3P/4P 1P/3P	B/C/D C	1-63A 1-63A	5KA 5KA
	DC	UL1077	1P/2P/3P/4P	B/C	1-63A	10KA
eB	AC	IEC/EN 60898-1	1P/2P/3P/4P	B/C/D	1-63A	3000A
B/C				1-40A	4500A	
UB	AC	IEC/EN 60947-2	2P	C	6-40A	6000A
DZ158	AC	IEC/EN 60898-1	1P/2P/3P/4P	B/C	1-40A	6000A
NBH8	AC	IEC/EN 60947-2	1P/2P/3P/4P	8-12In	63,80,100A	6KA
					63,80,100,125A	10KA
NL1	AC	IEC/EN 61008-1 VC8035	2P	AC/A	25,40,63A	6000A
			4P	AC/A	25,40,63A	6000A
			2P	AC/A	25,40,63A	10000A
			4P	AC/A	25,40,63A	10000A
			2P/4P	AC/A AC-S/A-S	63,80,100A	10000A
			2P/4P	AC	25,40,63A	6000/10000A
			2P/4P	AC	1-40A	6000A
NB1L (MCB+RCD block)	AC	IEC/EN 61009-1	2P/4P	AC/A	1-40A	10000A
NB1L (Combined)	AC	IEC/EN 61009-1	1P+N/2P/3P/3P+N/4P	AC	1-63A	6000A
			1P+N	A	1-25A	6000A
NB3LE	AC	IEC/EN 61009-1	2P	A	6-40A	10000A
NBH8LE	AC	IEC/EN 61009-1	1P+N	AC	6-32A	6000A
DZ158LE	AC	IEC/EN 61009-1	1P+N	AC	1-40A	4500/6000A
NH2	AC	IEC/EN 61009-1	1P+N/2P/3P/3P+N/4P	AC	63,80,100A	6000A
NH2	AC	IEC/EN 60947-3	1P/2P/3P/4P		32,63,100A	20le
NH4	AC	IEC/EN 60947-3	1P/2P/3P/4P		32,63,100,125A	20le
NH9	AC	IEC/EN 60947-3	1P/2P/3P/4P		16,32A	20le

CHINT

ZHEJIANG CHINT ELECTRICS CO.,LTD.

Add: No. 1, CHINT Road, CHINT Industrial Zone, North Baixiang,

Yueqing, Zhejiang, 325603, P.R.China

Tel: +86-577-62877777

Fax: +86-577-62775769 62871811

E-mail: global-sales@chint.com

Website: www.chint.net



Aug 2012

